

Montageanleitung

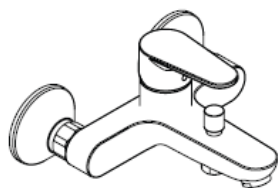

Talis E²
31642000

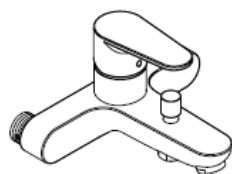

Talis E²
31643000



Talis E²
31662000



Talis E²
31667000

hangrohe

31642000

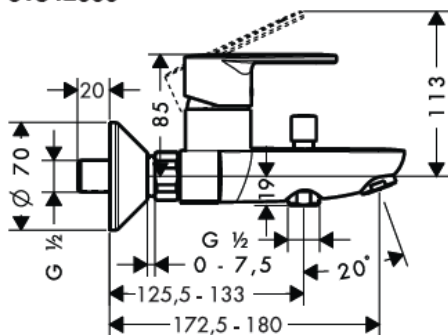

31662000

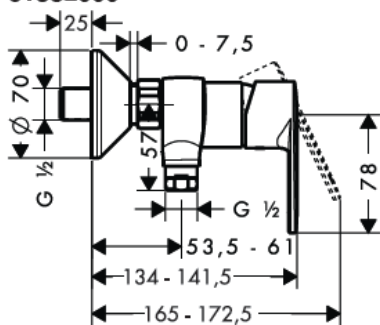

31643000

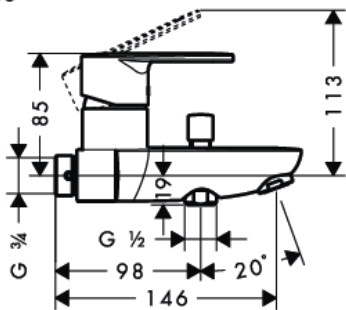

AD 153 mm

31667000

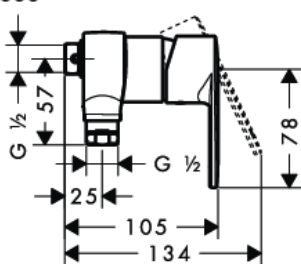

AD 153 mm

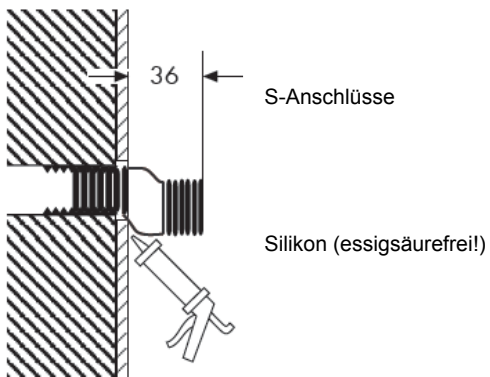



31642000

31662000 / 31667000

31642000 / 31643000

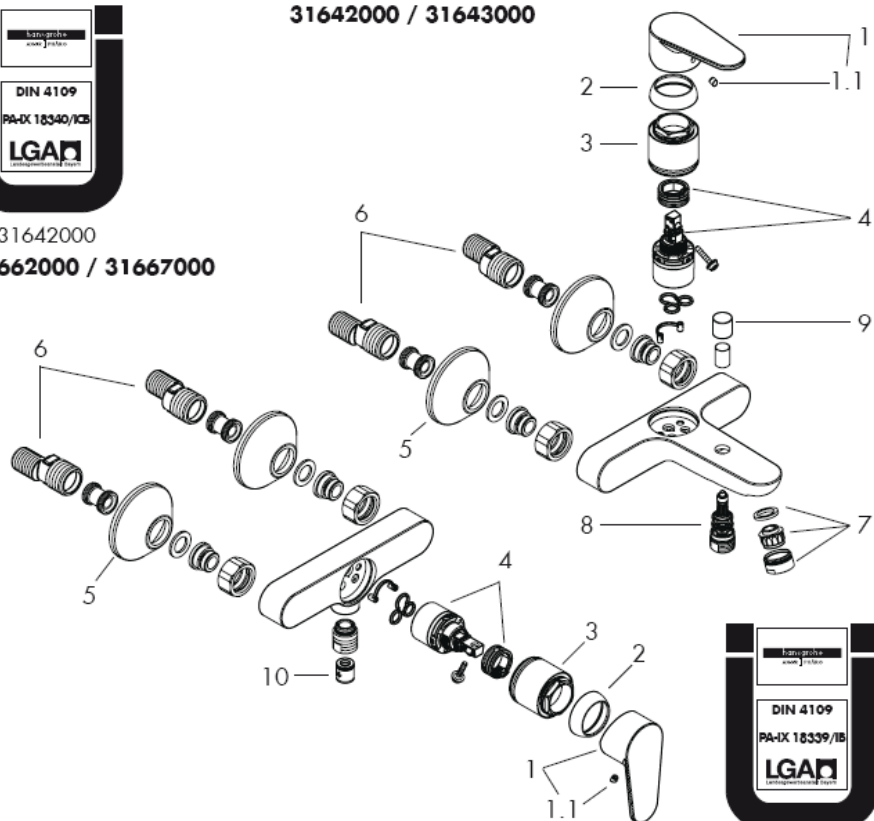

31662000

31643000 / 31667000

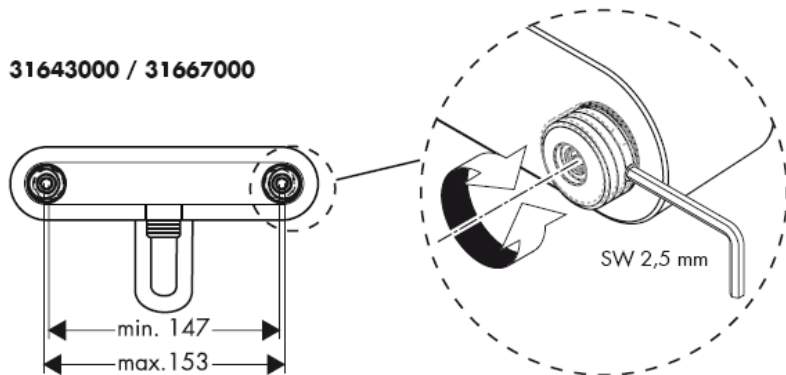

Achtung! Die Armatur muss nach den gültigen Normen montiert, gespült und geprüft werden!

1. Zulaufleitungen fachgerecht durchspülen.
2. S-Anschlüsse montieren und ausrichten.
3. Armatur mit Dichtungen festschrauben.

Große Druckunterschiede zwischen den Kalt- und Warmwasseranschlüssen müssen ausgeglichen werden.

Bedienung

Durch Anheben des Griffes wird der Mischer geöffnet.

Schwenkung nach links = warmes Wasser,
Schwenkung nach rechts = kaltes Wasser.

31642000 / 31643000 Umstellen zur Handbrause durch Ziehen am runden Knopf auf der Oberseite des Auslaufs. Die Rückstellung erfolgt nach Schließen des Griffes automatisch.

Technische Daten

Betriebsdruck: max. 1 MPa
Empfohlener Betriebsdruck: 0,1 – 0,5 MPa
Prüfdruck: 1,6 MPa
(1 MPa = 10 bar = 147 PSI)
Heißwassertemperatur: max. 80° C
Empfohlene Heißwassertemperatur: 65° C
Anschlussmaße:
Anschlüsse G ½": kalt rechts - warm links
Durchflussleistung: ca. 17 l/min 0,3 MPa
Eigensicher gegen Rückfließen

Einhandmischer mit Warmwasserbegrenzung, Justierung siehe Seite 6.

In Verbindung mit Durchlauferhitzern ist eine Warmwassersperre nicht notwendig.

Hansgrohe Einhandmischer können in Verbindung mit hydraulisch und thermisch gesteuerten Durchlauferhitzern eingesetzt werden wenn der Fließdruck mindestens 0,15 MPa beträgt.

Achtung!

Die Rückflussverhinderer müssen gemäß DIN 1988 einmal jährlich auf ihre Funktion geprüft werden.

Serviceteile (siehe Seite 3)

1	Griff	31692000
1.1	Griffstopfen	96338000
2	Kappe	97406000
3	Mutter	97977000
4	Kartusche kpl.	92730000
5	Rosette	96135000
6	S-Anschlüsse	94140000
7	Luftsprudler kpl.	96429000
8	Umsteller kpl.	13956000
9	Zugknopf	97978000
10	Rückflussverhinderer	97980000

Deutsch

Prüfzeichen

	PA-IX	DVGW	SVGW	KIWA	ACS	NF
31642000	PA-IX 18340/ICB	X	X	X	X	
31643000			X			
31662000	PA-IX 18339/IB	X	X	X	X	
31667000			X			

Störung	Ursache	Abhilfe
Wenig Wasser	-Siebdichtung der Brause verschmutzt -Rückflussverhinderer sitzt fest	-Siebdichtung zwischen Brause und Schlauch reinigen -Rückflussverhinderer austauschen
Armatur schwergängig	-Kartusche defekt, verkalkt	-Kartusche austauschen
Armatur tropft	-Kartusche defekt	-Kartusche austauschen
Zu niedere Warmwassertemperatur	-Warmwasserbegrenzung falsch eingestellt	-Warmwasserbegrenzung einstellen
Durchlauferhitzer schaltet nicht ein	-Drossel in der Handbrause nicht ausgebaut -Schmutzfangsiebe verschmutzt -Rückflussverhinderer sitzt fest	-Drossel aus der Handbrause entfernen -Schmutzfangsiebe reinigen / austauschen -Rückflussverhinderer austauschen

Warmwasserbegrenzung: Warmwassertemperatur 60 C, Kaltwassertemperatur 10 C, Fließdruck 0,3 MPa.

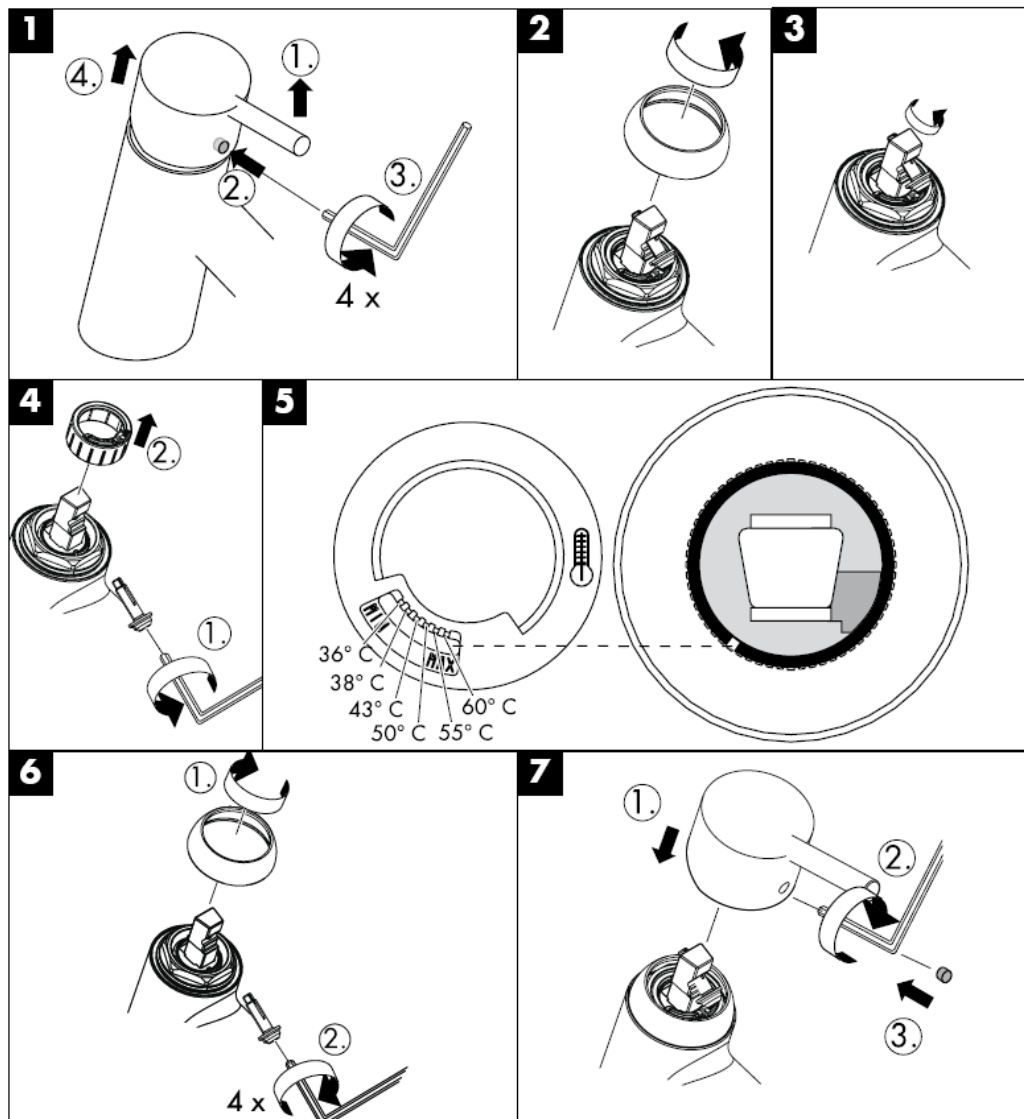

Reinigung

Mit QuickClean, der manuellen Reinigungsfunktion können die Strahlformer durch einfaches rubbeln vom Kalk befreit werden.

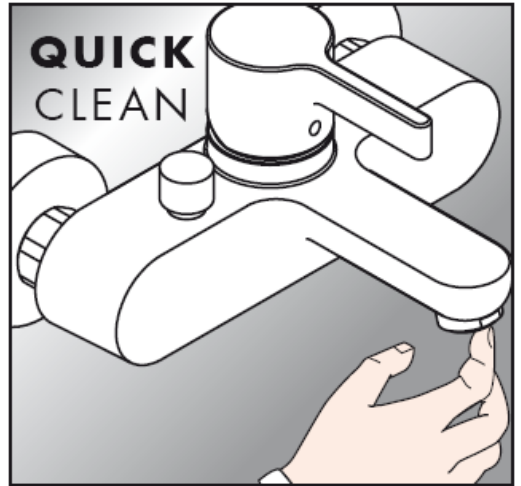

hansgrohe

Hansgrohe · Postfach 1145 · D-77761 Schiltach · Telefon +49 (0) 78 36/51-1282 · Telefax +49 (0) 7836/511440
E-Mail: info@hansgrohe.com · Internet: www.hansgrohe.com

11/2008
9.06851.01
Deutsch

Instructions de montage

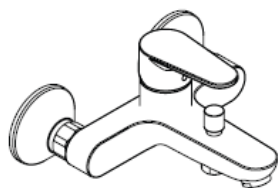

Talis E²
31642000

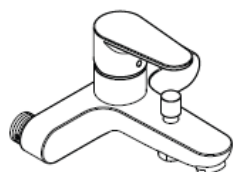

Talis E²
31643000



Talis E²
31662000



Talis E²
31667000

hangrohe

31642000

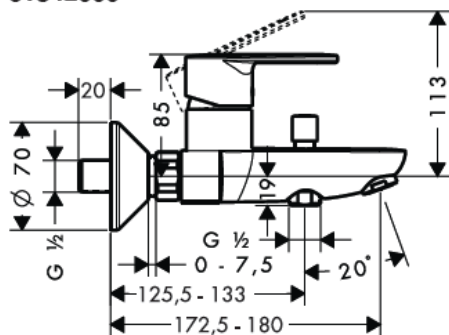

31662000

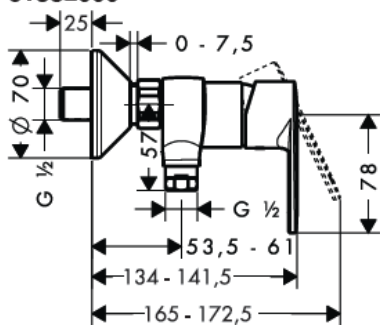

31643000

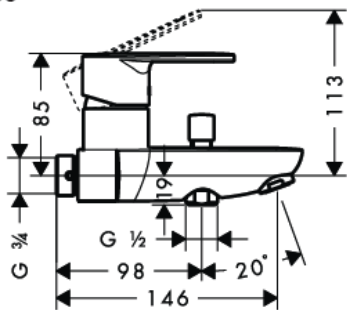

AD 153 mm

31667000

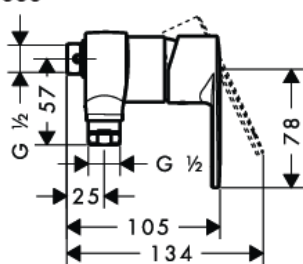

AD 153 mm

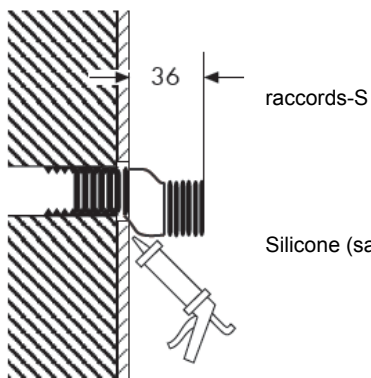



31642000

31662000 / 31667000

31642000 / 31643000



31662000

31643000 / 31667000

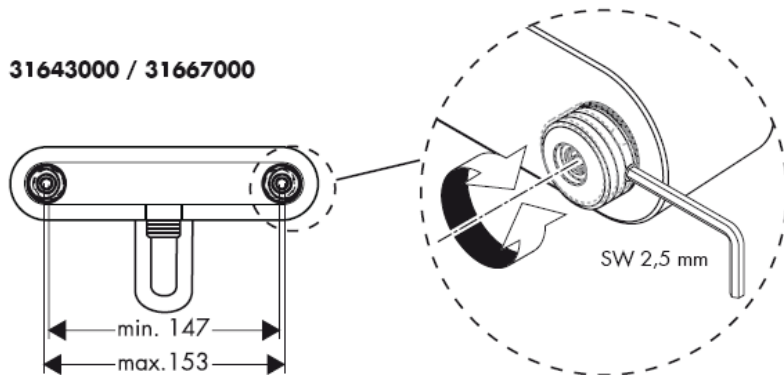

Attention! La robinetterie doit être installée, rincée et contrôlée conformément aux normes valables!

1. Purger les conduites d'alimentation.
2. Monter les raccords.
3. Visser la robinetterie avec les joints

Il est conseillé d'équilibrer les pressions de l'eau chaude et froide.

Instructions de service

En levant ou appuyant l'étrier de commande on actionne l'ouverture ou la fermeture du mitigeur. Tournant sur la droite = eau froide, tournant sur la gauche = eau chaude. 31642000 / 31643000 Pour l'inversion vers la douche tirer le bouton au-dessus du bec. L'inverseur revient automatiquement après la fermeture d'eau.

Informations techniques

Pression de service autorisée: max. 1 MPa
Pression de service conseillée: 0,1 – 0,5 MPa
Pression maximum de contrôle: 1,6 MPa
(1 MPa = 10 bar = 147 PSI)
Température max. d'eau chaude: max. 80° C
Température recommandée: 65° C

Dimension d'arrivée:

Raccordement G ½":froide à droite chaude à gauche entr'axe

Débit: ca. 17 l/min 0,3 MPa

Avec dispositif anti-retour

Mitigeur avec limitation de la température: consulter la page 6 pour le réglage

Une limitation de la température n'est pas nécessaire quand le mitigeur est alimenté par un chauffe-eau instantané.

Les mitigeurs monocommandes Hansgrohe fonctionnent également en association à des chauffe-eau à commande hydraulique ou thermique à condition que la pression soit au minimum de 0,15 MPa.

Attention!

Les clapets anti-retour doivent être vérifiés une fois par an.

Pièces détachées (voir page 3)

1	poignée	31692000
1.1	cache vis	96338000
2	capot sphérique	97406000
3	écrou	97977000
4	cartouche cpl.	92730000
5	flange	96135000
6	raccords-S	94140000
7	aérateur cpl.	96429000
8	inverseur cpl.	13956000
9	bouton d'inverseur	97978000
10	clapet anti-retour	97980000

Français

Classification acoustique et débit

	PA-IX	DVGW	SVGW	KIWA	ACS	NF
31642000	PA-IX 18340/ICB	X	X	X	X	
31643000			X			
31662000	PA-IX 18339/IB	X	X	X	X	
31667000			X			

Dysfonctionnement	Origine	Solution
Pas assez d'eau	-Joint-filtre de douchette encrassé -Clapet anti-retour bloqué	-Nettoyer le joint-filtre entre la douchette et le flexible -Changez le clapet antiretour
Durété de fonctionnement	-Cartouche défectueuse, entartrée	-Changer le cartouche
Le mitigeur goutte	-Cartouche défectueuse	-Changer le cartouche
Température d'eau chaude trop basse, pas d'eau froide	-Limiteur de température mal positionné	-Positionner le limiteur de température
La chauffe-eau instantané ne s'allume pas	-Réducteur de débit non démonté -Filtres encrassés -Clapet anti-retour bloqué	-Démonter le réducteur de débit de la douchette -Nettoyez / changez les filtres -Changez le clapet antiretour

Limiteur d'eau chaude: Température d'eau chaude 60 C, Température d'eau froide 10 C, Pression dynamique 0,3 MPa.

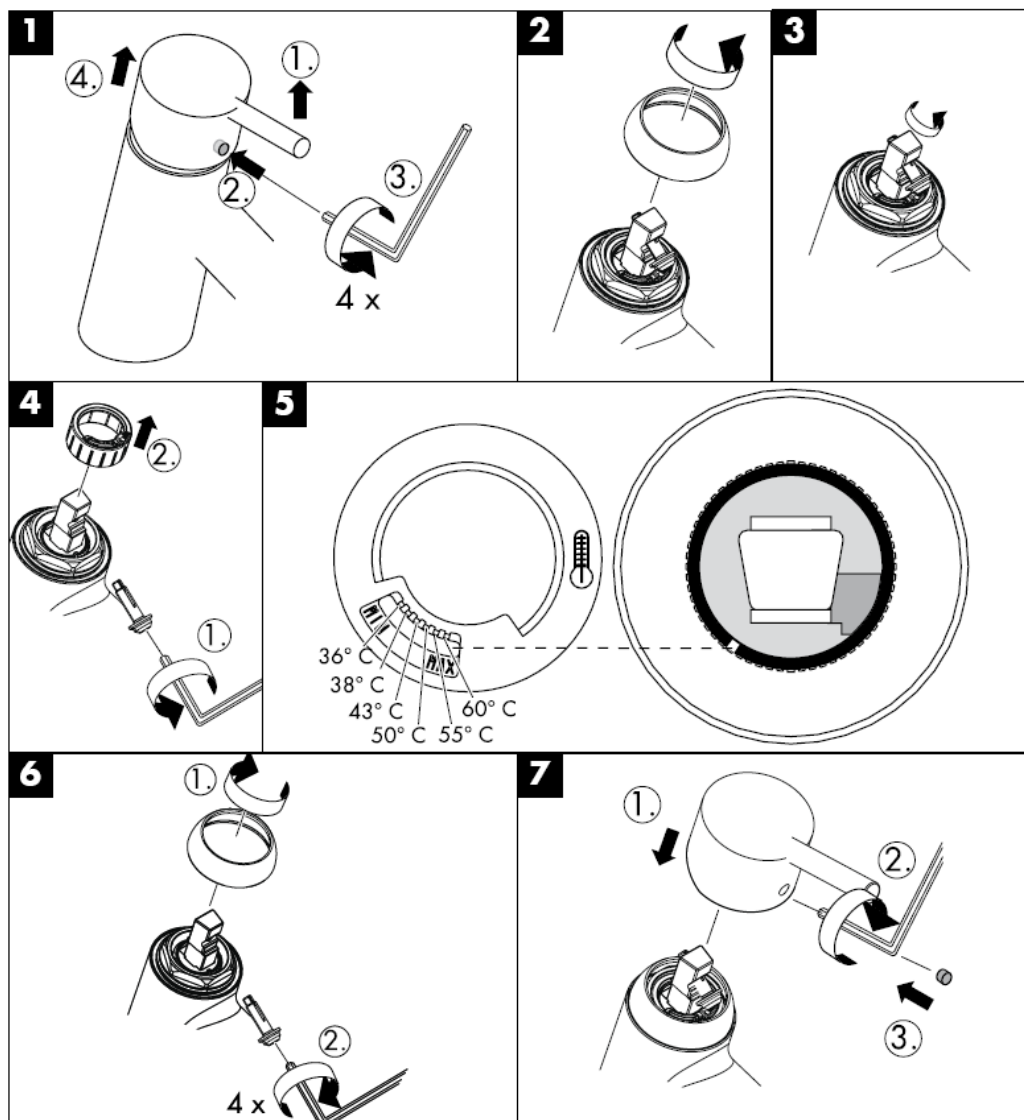

Nettoyage

La pomme de douche est équipée de QuickClean, le système anticalcaire manuel. Les dépôts de calcaire s'enlèvent en frottant avec un doigt ou avec une éponge sur les ouvertures de jets élastiques.

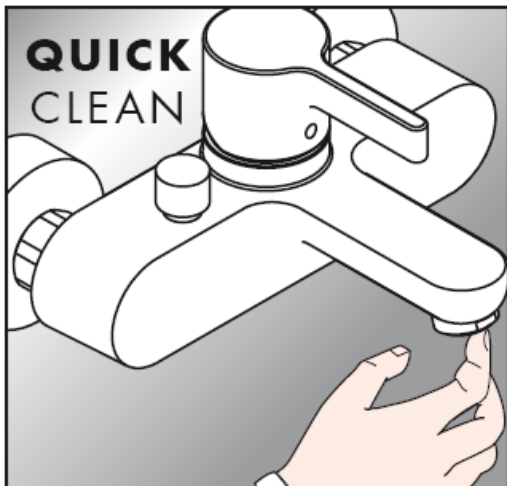

hansgrohe

Hansgrohe · Postfach 1145 · D-77761 Schiltach · Telefon +49 (0) 78 36/51-1282 · Telefax +49 (0) 7836/511440
E-Mail: info@hansgrohe.com · Internet: www.hansgrohe.com

11/2008
9.06851.01
Français

assembly instructions

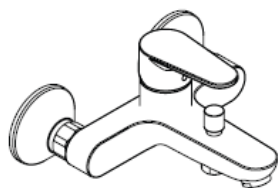

Talis E²
31642000

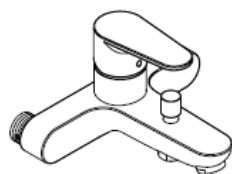

Talis E²
31643000



Talis E²
31662000



Talis E²
31667000

hansgrohe

31642000

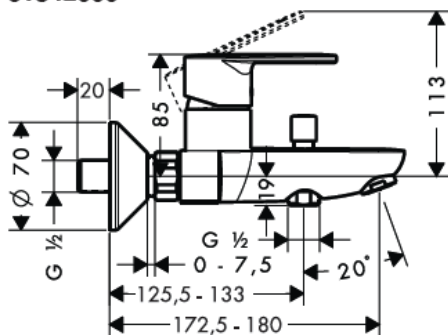

31662000

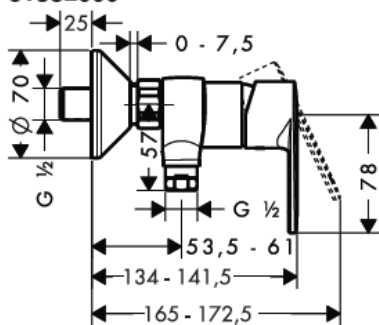

31643000

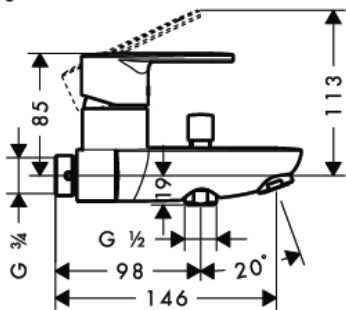

AD 153 mm

31667000

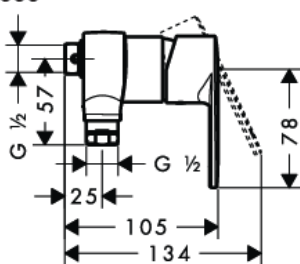

AD 153 mm

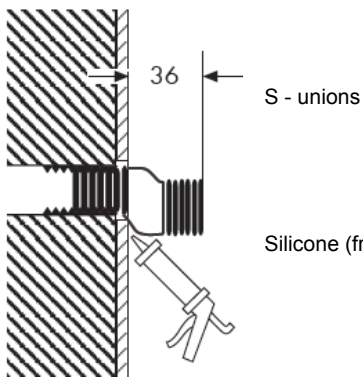



31642000

31662000 / 31667000

31642000 / 31643000



31662000

31643000 / 31667000

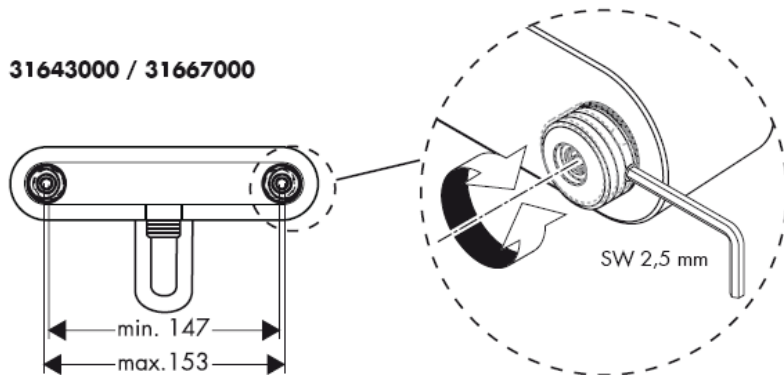

Important! The fitting must be installed, flushed and tested after the valid norms!

1. Flush through the supply pipes.
2. Mount the S - unions and align them.
3. Fasten the mixer with the washers.

The hot and cold supplies must be of equal pressures.

Operation

The mixer is activated by lifting the lever handle.

Turning to the left = warmer water,
turning to the right = cooler water.

31642000 / 31643000 The flow is changed from bath to shower function by pulling the knob at the upper side of the spout. After shutting off the water flow, the mixer returns automatically to the bath function.

Technical Data

Operating pressure: max. 1 MPa

Recommended operating pressure: 0,1 – 0,5 MPa

Test pressure: 1,6 MPa

(1 MPa = 10 bar = 147 PSI)

Hot water temperature: max. 80° C

Recommended hot water temp.: 65° C

Centre distance:

Connections G ½": cold right - hot left

Rate of flow: ca. 17 l/min 0,3 MPa

anti-pollution function

To adjust the hot water limiter on single lever mixers, please see page 6.

No adjustment is necessary when using a continuous flow water heater.

Hansgrohe single lever mixers can be used together with hydraulically and thermally controlled continuous flow heaters if the flow pressure is at least 0,15 MPa.

Important!

The non return valves must be checked once a year.

Spare parts (see page 3)

1	handle	31692000
1.1	screw cover	96338000
2	flange	97406000
3	nut	97977000
4	cartridge cpl.	92730000
5	flange	96135000
6	S - unions	94140000
7	aerator cpl.	96429000
8	selector assy	13956000
9	diverter knob	97978000
10	non return valve	97980000

English

Test certificate

	PA-IX	DVGW	SVGW	KIWA	ACS	NF
31642000	PA-IX 18340/ICB	X	X	X	X	
31643000			X			
31662000	PA-IX 18339/IB	X	X	X	X	
31667000			X			

Fault	Cause	Remedy
Insufficient water	-Shower filter seal dirty -Non return valve hasn't moved back	-Clean filter seal between shower and hose -Exchange non return valves
Mixer stiff	-Cartridge defective, calcified	-Exchange cartridge
Mixer dripping	-Cartridge defective	-Exchange cartridge
Hot water temperature too low	-Hot water limiter incorrectly set	-Set hot water limiter
Instantaneous heater didn't work	-Flow limiter in handshower isn't removed -Filters are dirty -Non return valve hasn't moved back	-Remove flow limiter -Clean the filter / exchange filter -Exchange non return valves

Hot water limiter: hot water temperature 60 C, cold water temperature 10 C, flow rate 0,3 MPa.

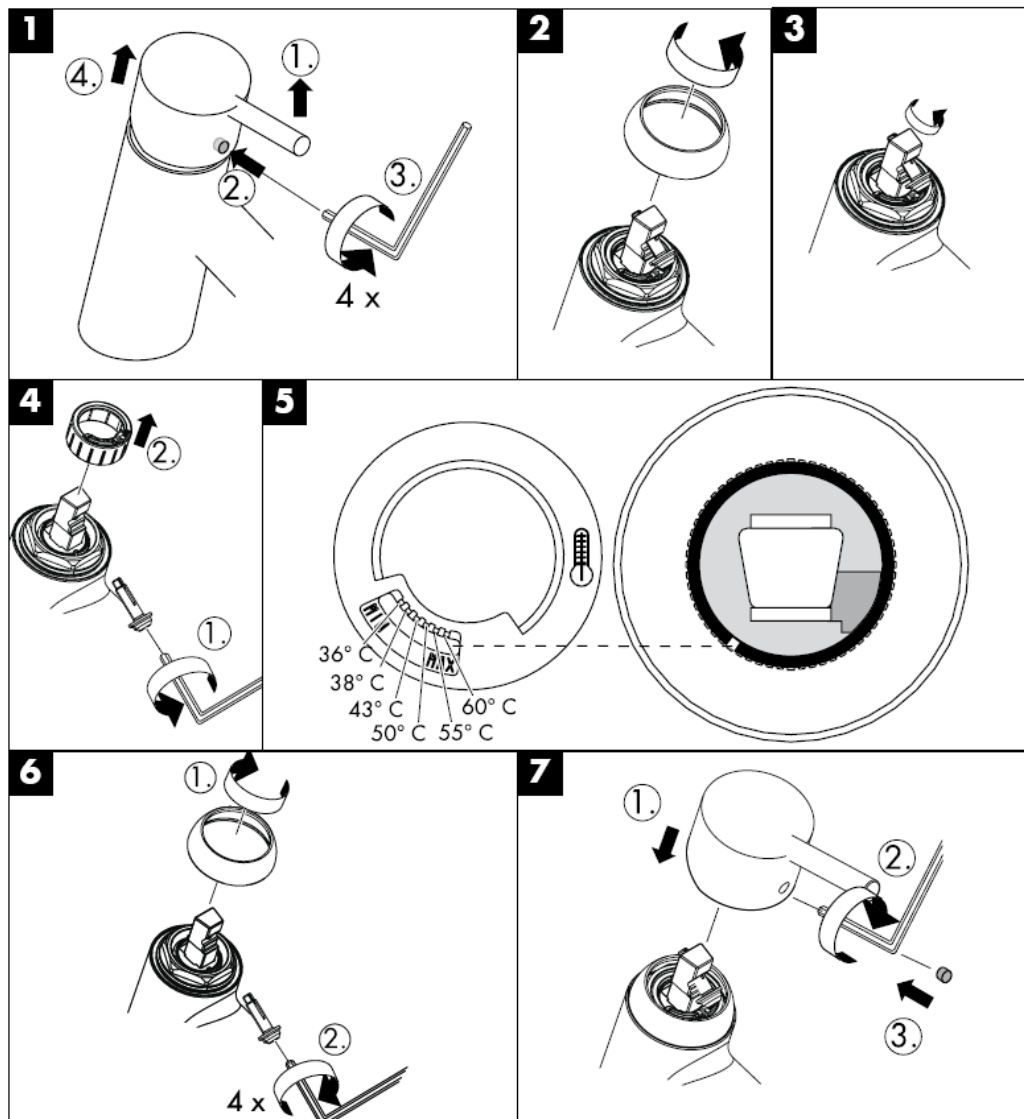

Cleaning

The QuickClean cleaning function only needs a small manual rub over to remove the lime scale from the spray channels.

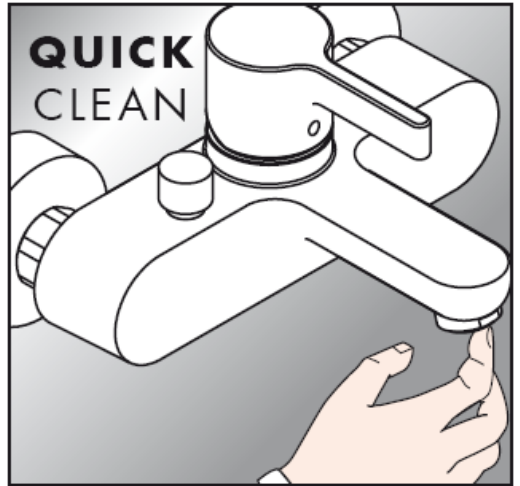

hansgrohe

Hansgrohe · Postfach 1145 · D-77761 Schiltach · Telefon +49 (0) 78 36/51-1282 · Telefax +49 (0) 7836/511440
E-Mail: info@hansgrohe.com · Internet: www.hansgrohe.com

11/2008
9.06851.01
English

Istruzioni per Installazione

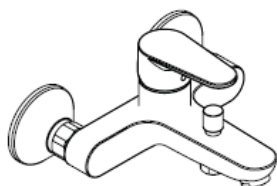

Talis E²
31642000

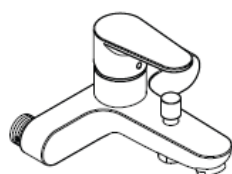

Talis E²
31643000



Talis E²
31662000



Talis E²
31667000

hansgrohe

31642000

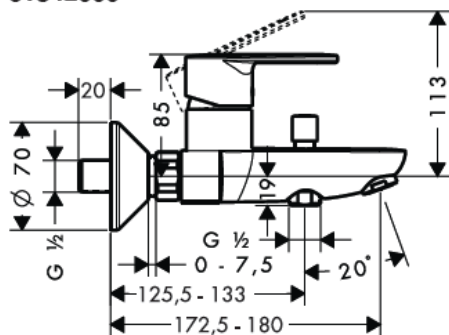

31662000

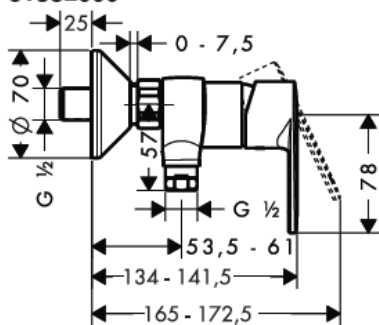

31643000

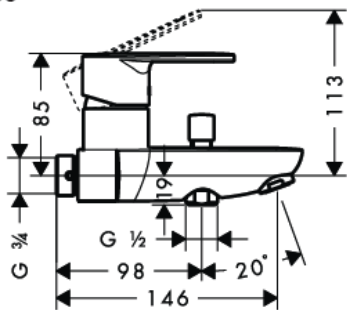

AD 153 mm

31667000

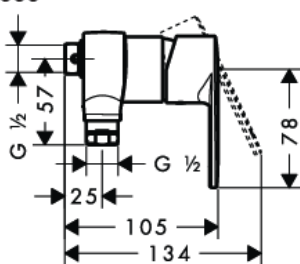

AD 153 mm

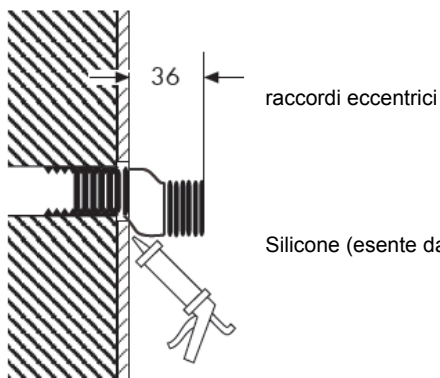



31642000

31662000 / 31667000

31642000 / 31643000



31662000

31643000 / 31667000

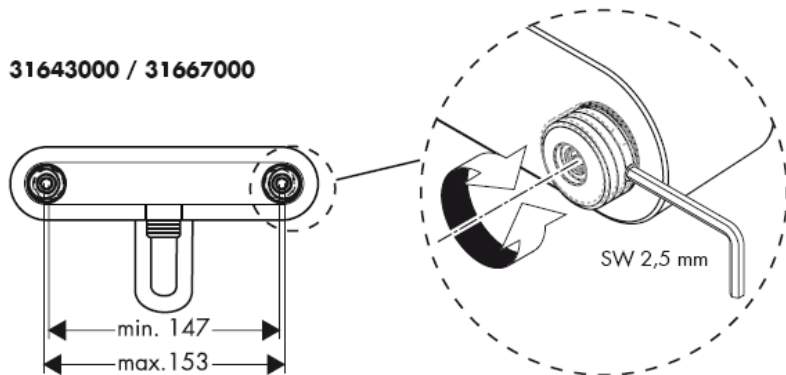

Attenzione! La rubinetteria deve essere installata, pulita e testata secondo le istruzioni riportate!

1. Collegare le uscite principali.
2. Montare i raccordi eccentrici.
3. Avvitare il rubinetto.

Attenzione! Compensare le differenze di pressione tra i collegamenti dell'acqua fredda e dell'acqua calda.

Procedura

Il miscelatore é azionato dal sollevamento della leva.

Girando a sinistra = acqua calda.

Girando a destra = acqua fredda.

31642000 / 31643000 Il flusso è cambiato dall'erogazione vasca alla funzione doccia tirando il pomello del deviatore sulla parte alta della bocca del miscelatore. Dopo avere chiuso l'acqua il miscelatore ritorna automaticamente all'erogazione vasca.

Dati tecnici

Pressione d'uso: max. 1 MPa
Pressione d'uso consigliata: 0,1 – 0,5 MPa
Pressione di prova: 1,6 MPa
(1 MPa = 10 bar = 147 PSI)
Temperatura dell'acqua calda: max. 80° C
Temp. dell'acqua calda consigliata: 65° C
Distanza di raccordo:
Raccordi G ½": fredda a destra calda a sinistra
Portata di erogazione: ca. 17 l/min 0,3 MPa
Sicurezza antiriflusso

Regolazione del limitatore di erogazione di acqua calde dei miscelatori monocomando, vedere pagina 6.

In combinazione con le caldaie istantanee, il limitatore di erogazione di acqua calda non è necessario.

I miscelatori Hansgrohe possono venire usati con caldaie a "bassa pressione" se la pressione del flusso è almeno di 0,15 MPa.

Attenzione!

La valvola di non ritorno deve essere controllata una volta all'anno.

Parti di ricambio (vedi pagg. 3)

1	maniglia	31692000
1.1	tappino	96338000
2	cappuccio	97406000
3	ghiera di fissaggio	97977000
4	cartuccia completa	92730000
5	copertura	96135000
6	raccordi eccentrici	94140000
7	rompigetto compl.	96429000
8	deviatore completo	13956000
9	pomello deviatore	97978000
10	valvola antiriflusso	97980000

Italiano

Segno di verifica

	PA-IX	DVGW	SVGW	KIWA	ACS	NF
31642000	PA-IX 18340/ICB	X	X	X	X	
31643000			X			
31662000	PA-IX 18339/IB	X	X	X	X	
31667000			X			

Problema	Possibile causa	Rimedio
Scarsità d'acqua	-Guarnizione del filtro della doccia sporca -Valvola antiriflusso non funziona correttamente	-Pulire la guarnizione del filtro tra doccia e flessibile -Sostituire la valvola antiriflusso
Miscelatore duro	-Cartuccia difettosa	-Sostituire la cartuccia
Miscelatore gocciola	-Cartuccia difettosa	-Sostituire la cartuccia
Temperatura dell'acqua calda	-Limitazione dell'acqua calda regolata male	-Regolare la limitazione dell'acqua calda
La caldaia istantanea non lavora	-Il limitatore di portata non è stato smontato dalla doccetta -Filtri sporchi -Valvola antiriflusso non funziona correttamente	-Smontare il limitatore di portata dalla doccetta -Pulire / sostituire i filtri -Sostituire la valvola antiriflusso

Limitatore di acqua calda: temperatura dell'acqua calda 60 C, temperatura dell'acqua fredda 10 C, pressione 0,3 MPa.

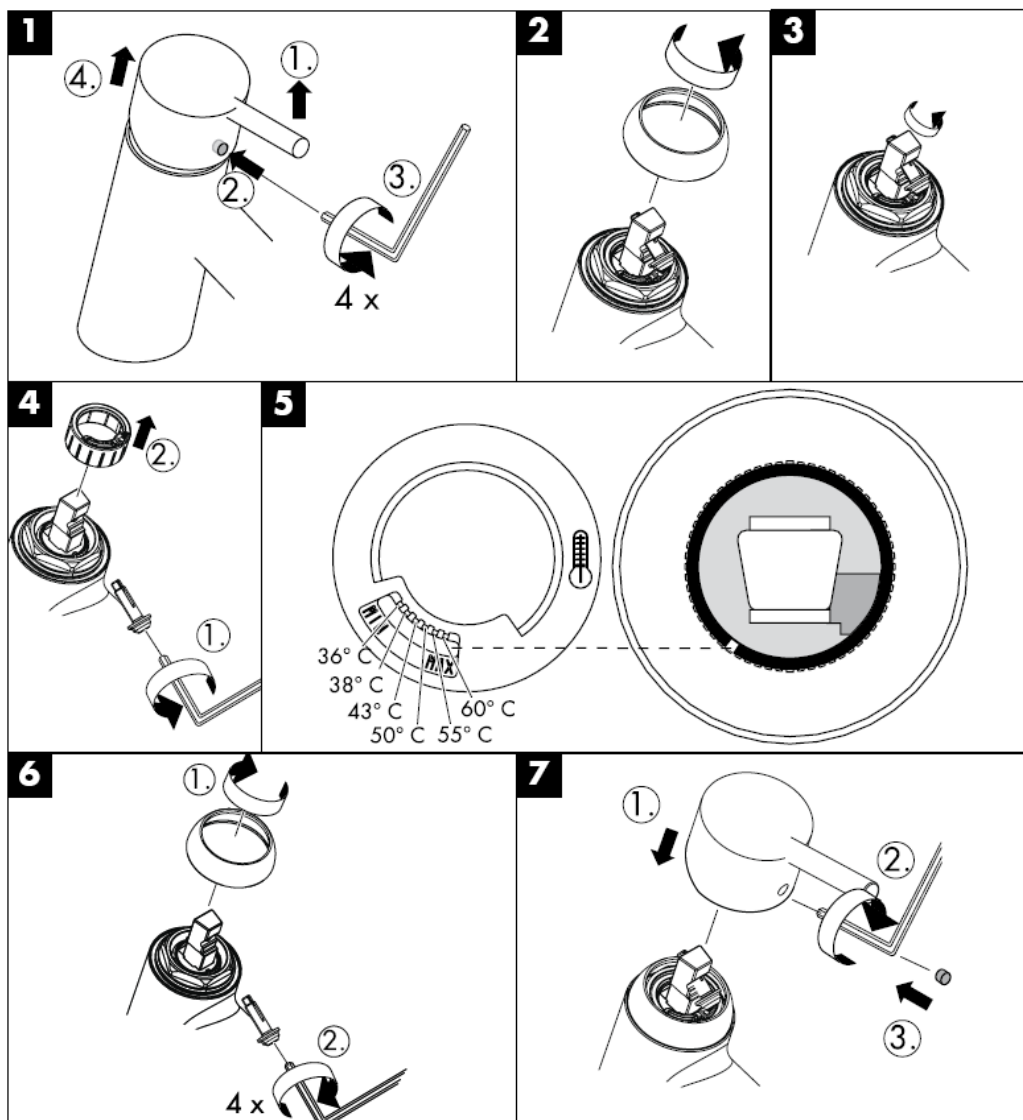

Pulitura

Con QuickClean, la funzione anticalcare manuale, i diffusori del getto possono essere liberati da calcare con un semplice strofinamento.

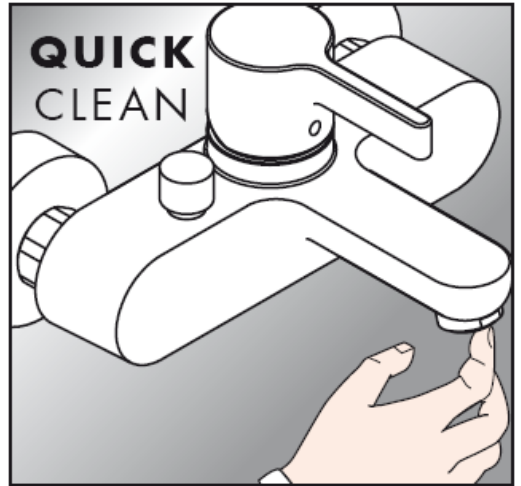

hansgrohe

Hansgrohe · Postfach 1145 · D-77761 Schiltach · Telefon +49 (0) 78 36/51-1282 · Telefax +49 (0) 7836/511440
E-Mail: info@hansgrohe.com · Internet: www.hansgrohe.com

11/2008
9.06851.01
Italiano

Instrucciones de montaje

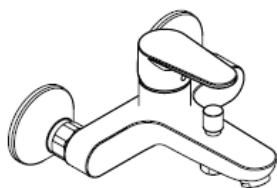

Talis E²
31642000

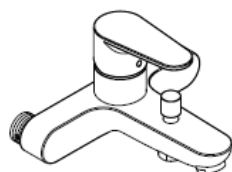

Talis E²
31643000



Talis E²
31662000



Talis E²
31667000

hansgrohe

31642000

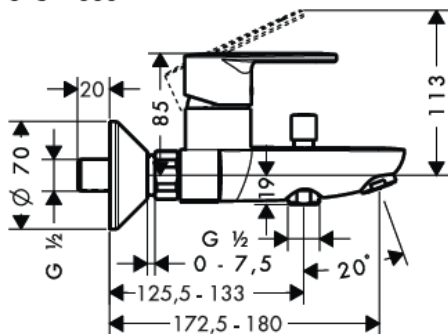

31662000

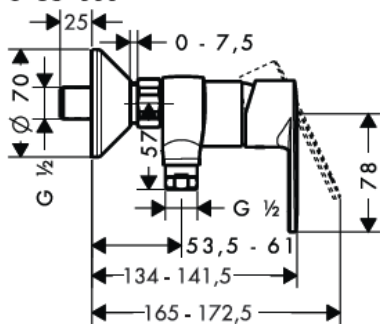

31643000

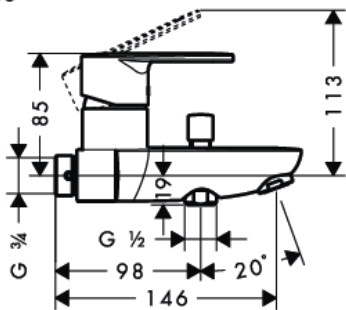

AD 153 mm

31667000

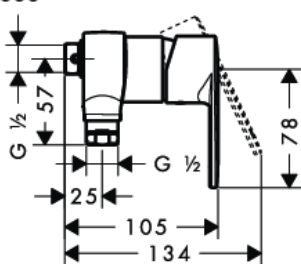

AD 153 mm

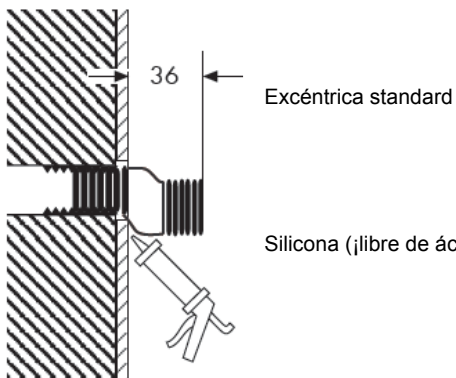



31642000

31662000 / 31667000

31642000 / 31643000

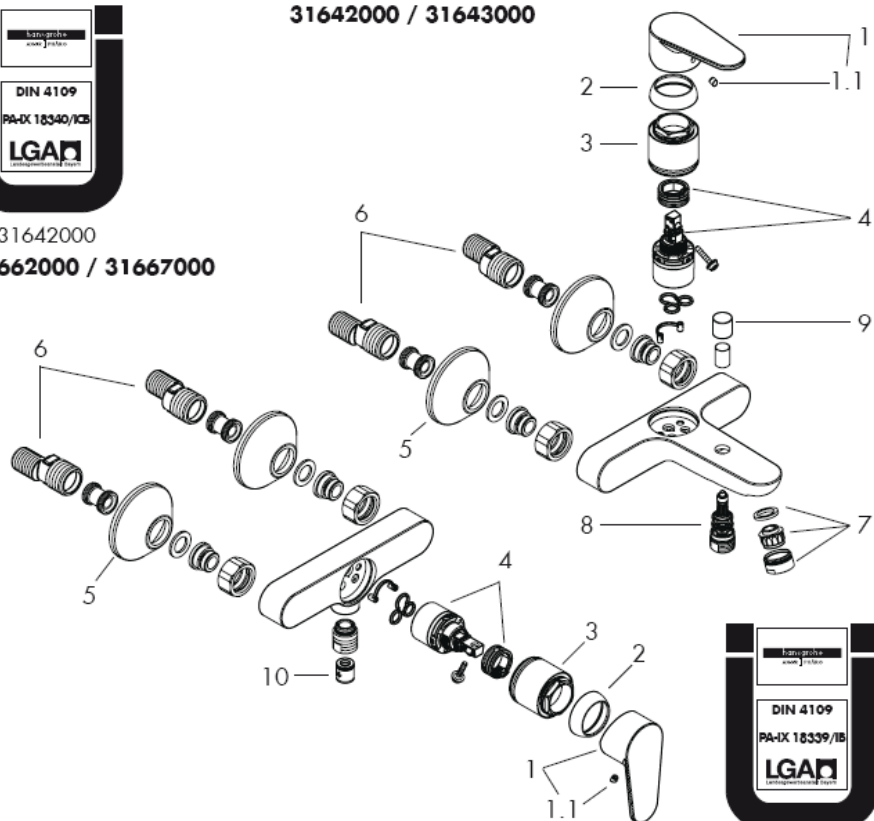

31662000

31643000 / 31667000

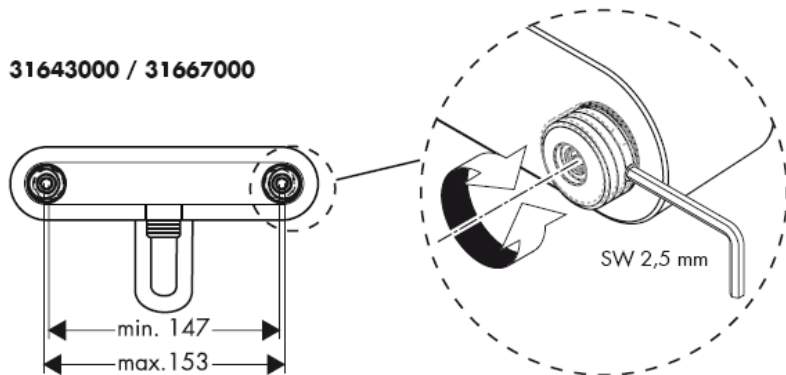

¡Atención! El grifo tiene que ser instalado, probado y testado, según las normas en vigor.

1. Purgar las tuberías de afluencia.
2. Montar los racores excéntricos.
3. Montar el mezclador.

Grandes diferencias de presión entre los empalmes de agua fría y agua caliente deben equilibrarse.

Manejo

El mezclador se abre levantando la manecilla hacia arriba.

Giro hacia la izquierda = agua caliente,

giro hacia la derecha = agua fría.

31642000 / 31643000 El inversor para la teleducha se activa al tirar del botón en la parte superior del caño.

Al cerrar el mando vuelve automáticamente a su posición inicial.

Datos técnicos

Presión en servicio: max. 1 MPa

Presión recomendada en servicio: 0,1 – 0,5 MPa

Presión de prueba: 1,6 MPa

(1 MPa = 10 bar = 147 PSI)

Temperatura del agua caliente: max. 80° C

Temp. recomendada del agua

caliente: 65° C

Racores excéntricos:

Racores excéntricos G ½": a la derecha frío - a la izquierda caliente

Caudal máximo: ca. 17 l/min 0,3 MPa

Seguro contra el retorno

Mezclador monomando con limitación del caudal de agua caliente; ajuste ver pagina 6.

En combinación con calentadores instantáneos no es necesario una limitación del caudal de agua caliente.

Los mezcladores Hansgrohe pueden ser utilizado junto con calentadores continuos de agua que sean manejados de manera hidráulica o térmica, siempre que la presión del caudal ascienda a un mínimo de 0,15 MPa.

¡Atención!

Las válvulas anti-retorno se han de revisar una vez al año.

Repuestos (ver página 3)

1	Mando	31692000
1.1	Tapón	96338000
2	Florón	97406000
3	Tuerca	97977000
4	Cartucho completo	92730000
5	Embellecedor	96135000
6	Excéntrica standard	94140000
7	Aireador completo	96429000
8	Inversor	13956000
9	Tirador inversor	97978000
10	Válvula antirretorno	97980000

Español

Marca de verificación

	PA-IX	DVGW	SVGW	KIWA	ACS	NF
31642000	PA-IX 18340/ICB	X	X	X	X	
31643000			X			
31662000	PA-IX 18339/IB	X	X	X	X	
31667000			X			

Problema	Causa	Solución
Sale poca agua	-filtro de la ducha sucio -válvula anti-retorno cerrada	-limpiar/cambiar filtros entre flexo y ducha -cambiar válvula anti-retorno
Manecilla va dura	-cartucho dañado	-cambiar el cartucho
Grifo pierde agua	-cartucho dañado	-cambiar el cartucho
temperatura del agua demasiado baja no hay	-tope de agua caliente mal	-ajustar tope
Calentador instantáneo no se enciende	-no se ha quitado limitador de caudal de la teleducha -filtro de la ducha sucio -válvula anti-retorno cerrada	-quitar limitador de caudal -limpiar/cambiar filtros -cambiar válvula anti-retorno

Limitación del agua caliente: temperatura del agua caliente 60 C, temperatura del agua fría 10 C, presión dinámica 0,3 MPa.

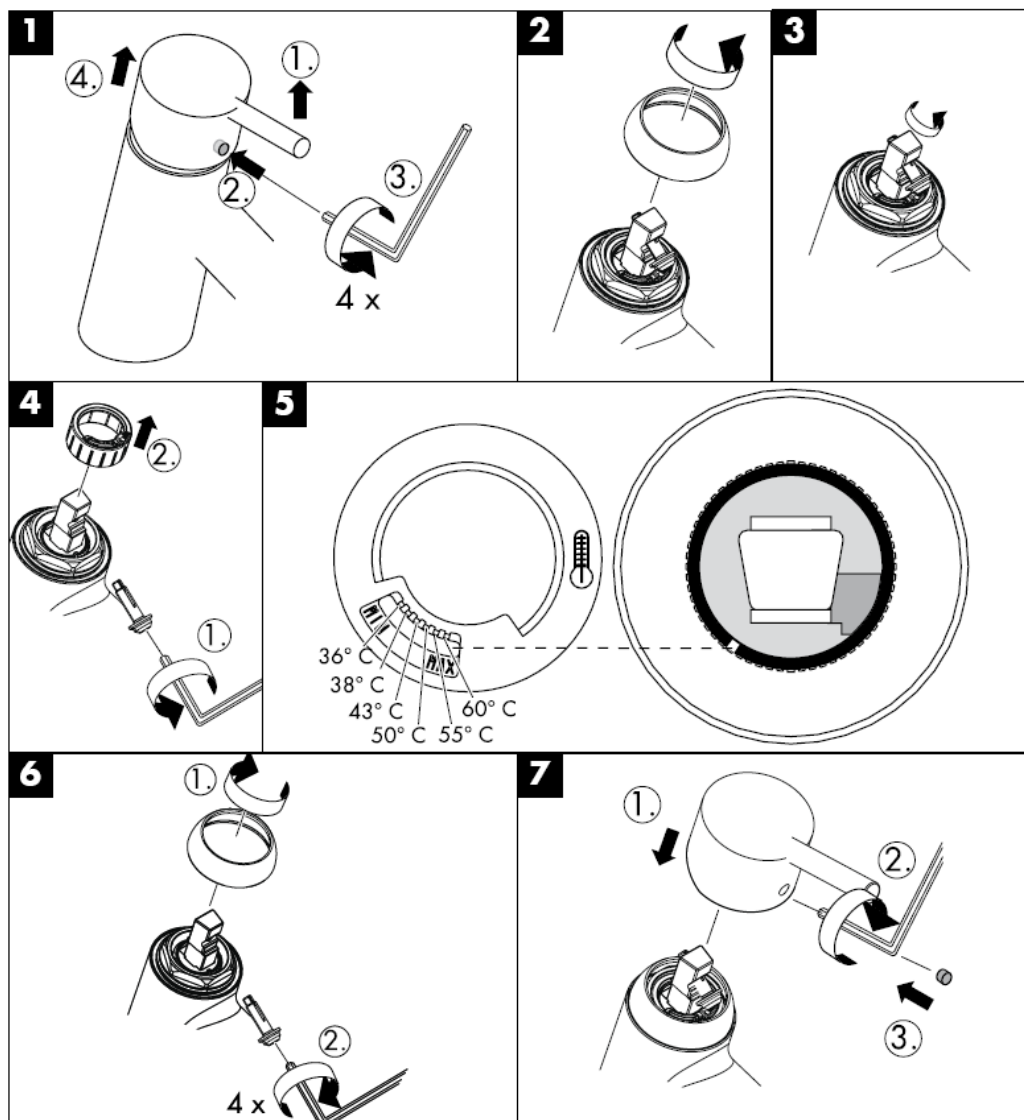

Limpiar

QuickClean, la función de limpieza manual, permite quitar la cal simplemente frotando los ejectores.

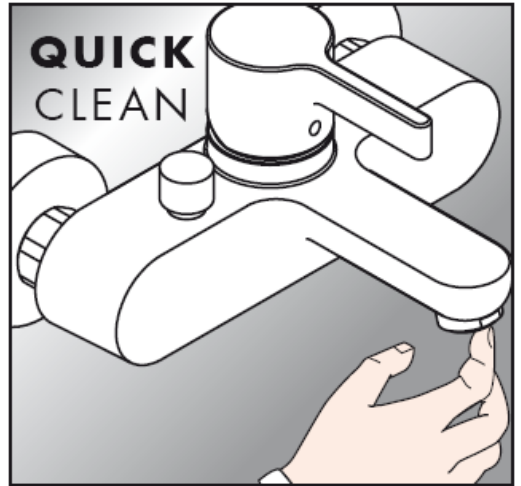

hansgrohe

Hansgrohe · Postfach 1145 · D-77761 Schiltach · Telefon +49 (0) 78 36/51-1282 · Telefax +49 (0) 7836/511440
E-Mail: info@hansgrohe.com · Internet: www.hansgrohe.com

11/2008
9.06851.01
Español

Handleiding

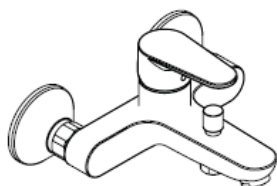

Talis E²
31642000

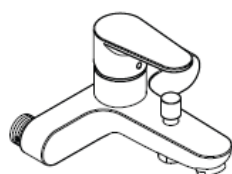

Talis E²
31643000



Talis E²
31662000

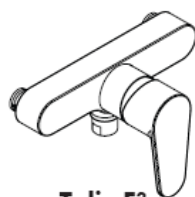

Talis E²
31667000

hansgrohe

31642000

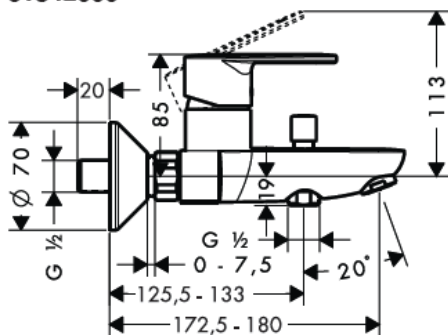

31662000

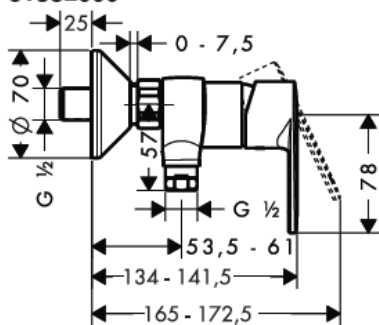

31643000

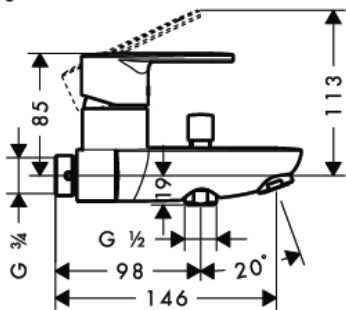

AD 153 mm

31667000

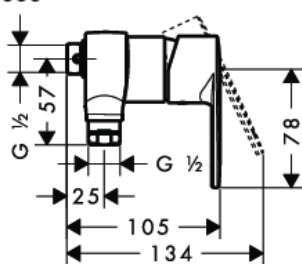

AD 153 mm

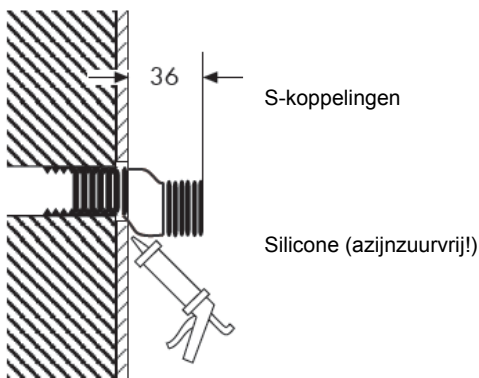



31642000

31662000 / 31667000

31642000 / 31643000



31662000

31643000 / 31667000

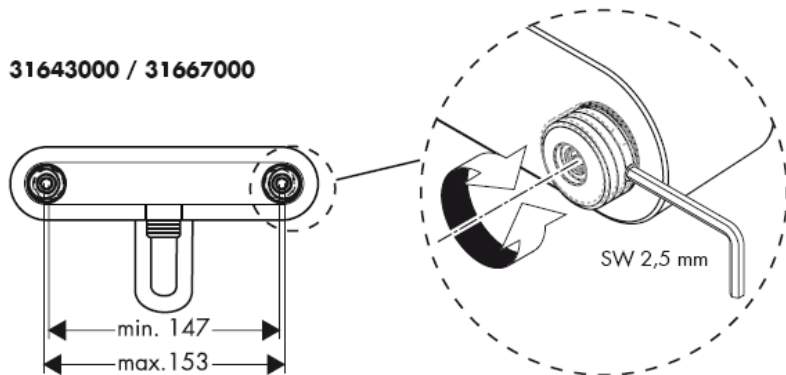

Attentie! Leidingen doorspoelen volgens Norm. De mengkraan vervolgens monteren en controleren!

1. Toevoerleidingen vakkundig doorspoelen.
2. S - koppelingen monteren.
3. Met de vastzetmoeren het armatuur aandraaien.

Grote drukverschillen tussen de kouden warm wateraansluitingen dienen vermeden te worden.

Bediening

Door het bedienen van de beugelgreep wordt de mengkraan geopend.

Naar links bewegen = warm water,
naar rechts = koud water.

31642000 / 31643000 Het omstellen naar de handdouche gaat middels het trekken aan de ronde knop boven de uitloop. Het terugstellen naar de uitloop volgt automatisch na het sluiten van de greep.

Technische gegevens

Werkdruk: max. max. 1 MPa
Aanbevolen werkdruk: 0,1 – 0,5 MPa
Getest bij: 1,6 MPa
(1 MPa = 10 bar = 147 PSI)
Temperatuur warm water: max. 80° C
Aanbevolen warm water temp.: 65° C
Aansluitmaten:
Aansluitingen G ½": koud rechts - warm links
Doorstroomcapaciteit: ca. 17 l/min 0,3 MPa
Beveiligd tegen terugstromen

Eéngreepsmengkranen met warmwaterbegrenzing, instelling zie blz. 6. In combinatie met geisers is een warmwaterbegrenzing niet noodzakelijk.

Hansgrohe eéngreepsmengkranen kunnen samen met hydraulisch en thermisch gestuurde geisers gebruikt worden indien de uitstroomdruk min. 0,15 MPa bedraagt.

Attentie!

Het functioneren van de terugslagklep-pen moet jaarlijks worden getest.

Service onderdelen (zie blz. 3)

1	greep	31692000
1.1	greepstopje	96338000
2	afdekkap	97406000
3	moer	97977000
4	kardoes kompl.	92730000
5	rozet	96135000
6	S-koppelingen	94140000
7	perlator kompl.	96429000
8	omstelling kompl.	13956000
9	trekknop	97978000
10	terugslagklep	97980000

Nederlands

Keurmerk

	PA-IX	DVGW	SVGW	KIWA	ACS	NF
31642000	PA-IX 18340/ICB	X	X	X	X	
31643000			X			
31662000	PA-IX 18339/IB	X	X	X	X	
31667000			X			

Storing	Oorzaak	Oplossing
Weinig water	-Zeefdichting handdouche verstopt -Terugslagklep zit vast	-Zeefdichting handdouche reinigen -Terugslagklep uitwisselen
bediening zwaar	-Kardoes defect of verkalkt	-Kardoes uitwisselen
Mengkraan lekt	-Kardoes defect	-Kardoes uitwisselen
Temperatuur van warm water te laag	-Heetwaterbegrenzer verkeerd ingesteld	-Heetwaterbegrenzer instellen
Doorstroomtoestel schakelt niet in	-Begrenzer van handdouche niet verwijderd -Vuilzeef vverstopt -Terugslagklep zit vast	-Begrenzer uit handdouche verwijderen -Vuilvangzeef reinigen / uitwisselen -Terugslagklep uitwisselen

Warmwaterbegrenzing: Warmwatertemperatuur 60 C, Koudwatertemperatuur 10 C, stroomdruk 0,3 MPa.

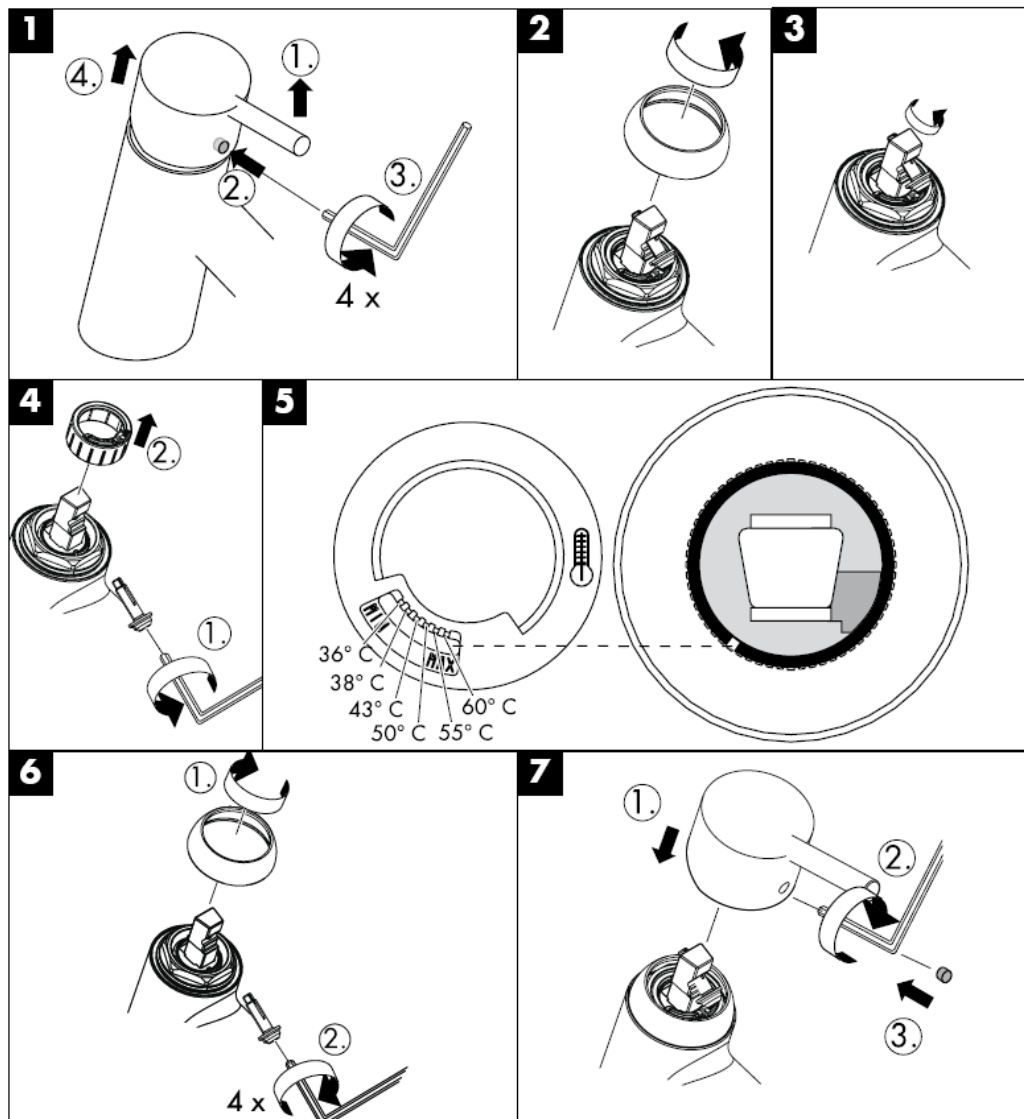

Reinigen

Met QuickClean, de handmatige reinigingsfunctie, kunnen de straalopeningen door het met de hand wegwrijven van kalk, gereinigd worden.

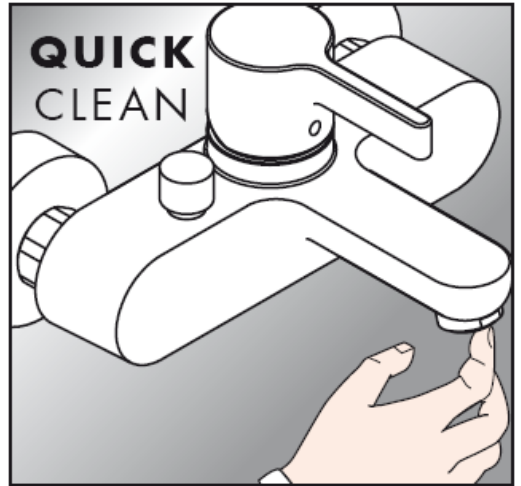

hansgrohe

Hansgrohe · Postfach 1145 · D-77761 Schiltach · Telefon +49 (0) 78 36/51-1282 · Telefax +49 (0) 7836/511440
E-Mail: info@hansgrohe.com · Internet: www.hansgrohe.com

11/2008
9.06851.01
Nederlands

Monteringsvejledning

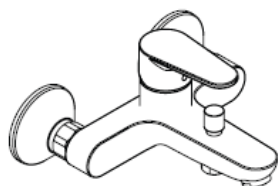

Talis E²
31642000

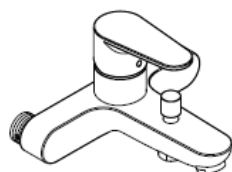

Talis E²
31643000



Talis E²
31662000



Talis E²
31667000

hansgrohe

31642000

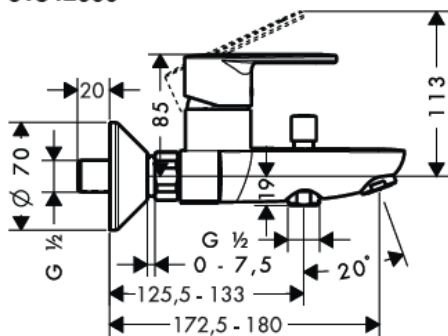

31662000

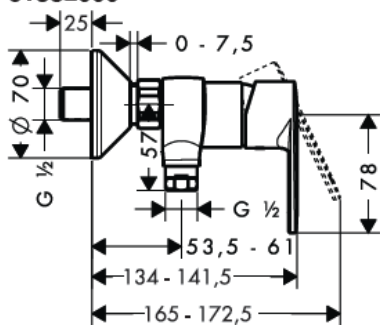

31643000

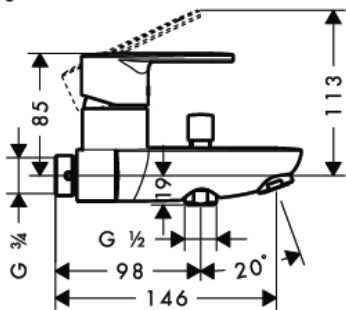

AD 153 mm

31667000

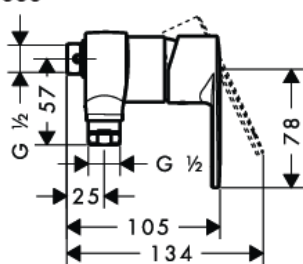

AD 153 mm

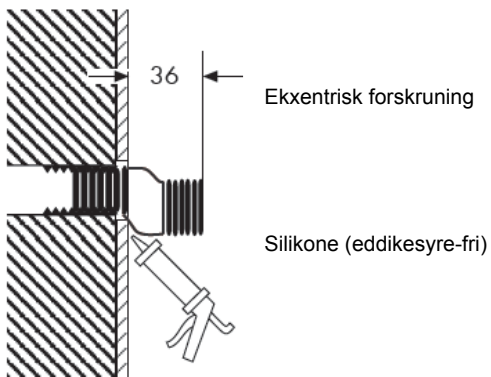



31642000

31662000 / 31667000

31642000 / 31643000



31662000

31643000 / 31667000

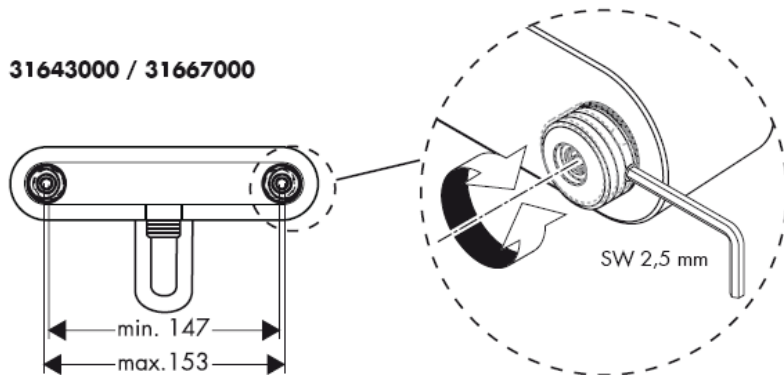

Advarsel! Ifølge gældende regler, skal armaturet monteres, skylles igennem og afprøves.

1. Skyl tilførselsledningene grundig.
2. Montér de eksentriske forskruninger.
3. Skru armaturet fast.

Større trykforskelte mellem koldt og varmt vand bør udjævnes.

Brugsanvisning

Ved at hæve bøjlegrebet åbnes for vandet.

Drejning til venstre = varmt vand,
drejning til højre = koldt vand.

31642000 / 31643000 For omstilling til håndbruser trækkes i den runde knop på oversiden af udløbstuden. Tilbagestilling sker automatisk, når der lukkes for vandet.

Tekniske data

Driftstryk: max. 1 MPa
Anbefalet driftstryk: 0,1 – 0,5 MPa
Prøvetryk: 1,6 MPa
(1 MPa = 10 bar = 147 PSI)
Varmtvandstemperatur: max. 80° C
Anbefalet varmtvandstemperatur: 65° C
Tilslutningsmål:
Tilslutninger G ½": Koldt højre - varmt venstre
Gennemstrømningskapacitet: ca. 17 l/min 0,3 MPa
Med indbygget kontraventil

Etgrebsarmaturer med varmtvandsbegrænsning, justering se side 6.

I forbindelse med gennemstrømningsvandvarmer er en varmtvandsbegrænsning ikke nødvendig.

Hansgrohe etgrebsarmaturer kan anvendes i forbindelse med hydraulisk- og termiskstyrede gennemstrømningsvandvarmere ved et vandtryk på 0,15 MPa.

Advarsel!

Kontraventilen skal afprøves en gang om året.

Reserveudede (se s. 3)

1	Greb	31692000
1.1	Dækknap til greb	96338000
2	Dækskive	97406000
3	Møtrik	97977000
4	Indmad	92730000
5	Roset	96135000
6	Ekxentrisk forskruning	94140000
7	Perlator kpl.	96429000
8	Omstiller	13956000
9	Trykknapp	97978000
10	terugslagklep	97980000

Dansk

Godkendelse

	PA-IX	DVGW	SVGW	KIWA	ACS	NF
31642000	PA-IX 18340/ICB	X	X	X	X	
31643000			X			
31662000	PA-IX 18339/IB	X	X	X	X	
31667000			X			

Fejl	Årsag	Hjælp
For lidt vand	-Sien mellem bruser og slange er snavset -Kontraventilen hænger	-Rengør sien mellem bruser og slange -Udskift kontraventil
Grebet går trægt	-Kartusche defekt, tilkalket	-Udskift kartusche
Armaturet drypper	-Defekt kartusche	-Kardoes uitwisselen
For lav varmtvands-temperatur	-Varmtvandsbegrænsningen er forkert indstillet	-Indstil varmtvandsbegrænsningen
Vandvarmeren går ikke i gang	-Vandsparen i håndbruseren er ikke fjernet -Smudsfangsi er snavset -Kontraventilen hænger	-Afmontér vandsparen i håndbruseren -Rengør/udskift smudsfangsi -Udskift kontraventil

Varmtvandsbegrænsning: Varmtvandstemperatur 60o C, koldtvandstemperatur 10o C, vandtryk 0,3 MPa.

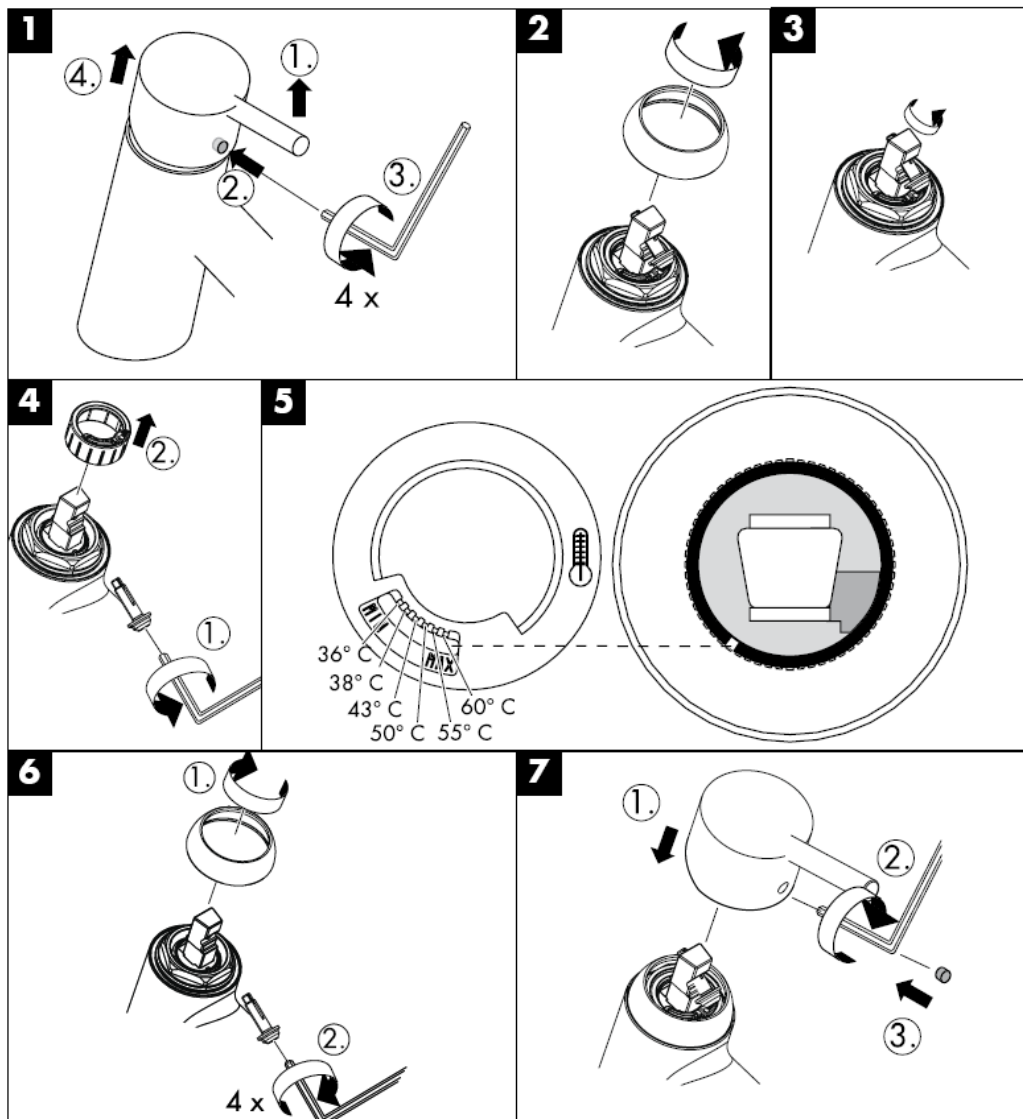

Rengøring

Med QuickClean, den manuelle rengøringsfunktion kan strålekanalerne let renses for kalk - der skal blot gribes!

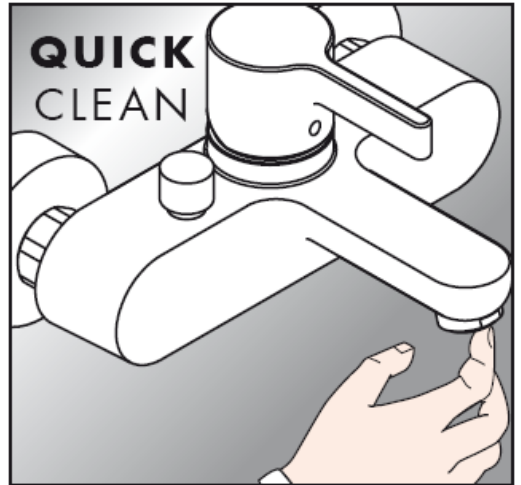

hansgrohe

Hansgrohe · Postfach 1145 · D-77761 Schiltach · Telefon +49 (0) 78 36/51-1282 · Telefax +49 (0) 7836/511440
E-Mail: info@hansgrohe.com · Internet: www.hansgrohe.com

11/2008
9.06851.01
Dansk

Manual de Instalación

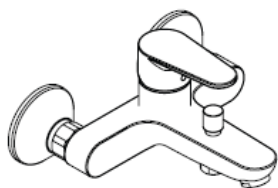

Talis E²
31642000

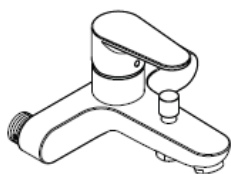

Talis E²
31643000

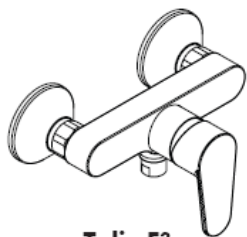

Talis E²
31662000



Talis E²
31667000

hansgrohe

31642000

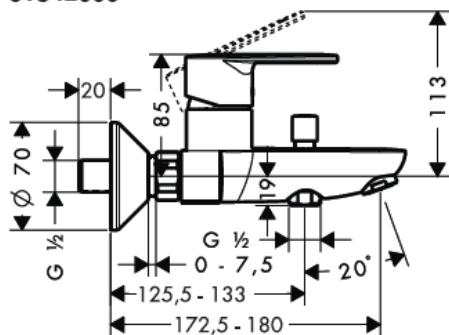

31662000

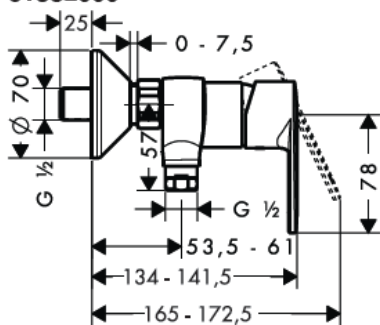

31643000

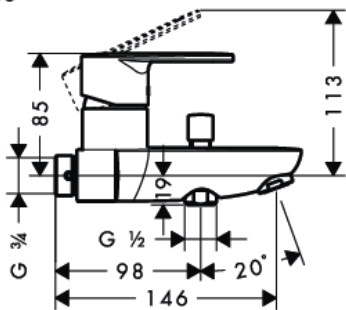

AD 153 mm

31667000

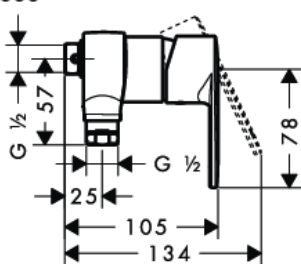

AD 153 mm

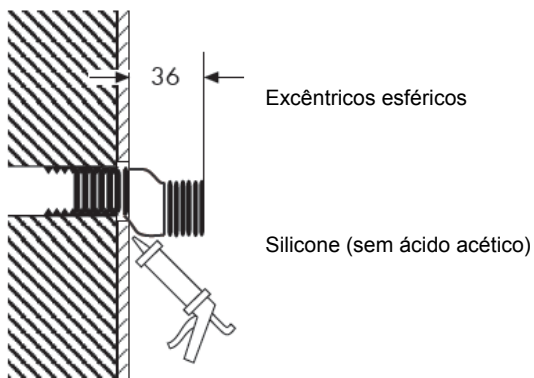



31642000

31662000 / 31667000

31642000 / 31643000

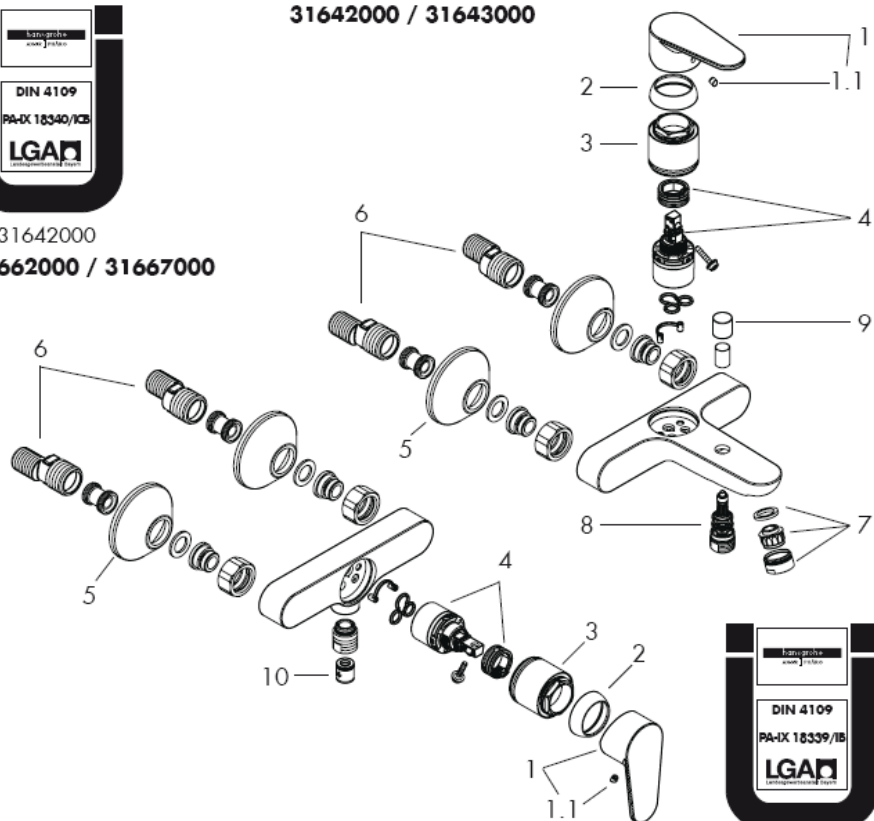

31662000

31643000 / 31667000

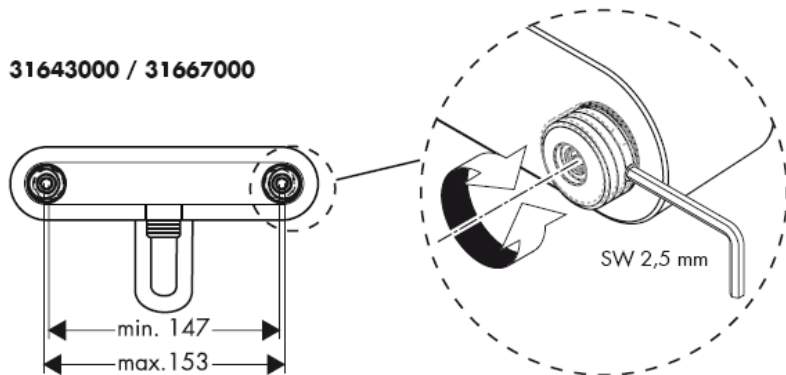

Atenção! A misturadora deve ser instalada, purgada e testada de acordo com as normas em vigor!

1. Purgue a canalização.
2. Colocar os excêntricos.
3. Fixar a misturadora aos excêntricos, com os vedantes.

Grandes diferenças entre as pressões das águas quente e fria devem ser compensadas.

Funcionamento

A misturadora é aberta levantando o manípulo de alavanca.

Rodando para a esquerda = água quente.

Rodando para a direita = água fria.

31642000 / 31643000 O fluxo de água é desviado da banheira para o chuveiro ao puxar manípulo colocado na parte superior da bica. Depois de fechar a água a misturadora volta automaticamente a debitar água pela bica.

Dados Técnicos

Pressão de funcionamento: max. 1 MPa

Pressão de func. recomendada: 0,1 – 0,5 MPa

Pressão testada: 1,6 MPa

(1 MPa = 10 bar = 147 PSI)

Temperatura da água quente: max. 80° C

Temp. água quente recomendada: 65° C

Distância entre eixos:

Ligações G ½": fria à direita - quente à esquerda

Caudal: ca. 17 l/min 0,3 MPa

Função anti-retorno e anti-vácuo

Misturadora monocomando equipada com limitador de temperatura (vide pág.6).

Em combinação com caldeira ou esquentador instantâneo o limitador de água quente não se aplica.

As misturadoras monocomando Hansgrohe podem ser utilizadas com esquentadores (de controlo térmico ou hidráulico) desde que a pressão de utilização seja, no mínimo, de 0,15 MPa.

Atenção!

As válvulas anti-retorno têm que ser verificadas uma vez por ano.

Peças de substituição (ver página 3)

1	Manípulo	31692000
1.1	Tampa de parafuso	96338000
2	Espelho	97406000
3	Porca	97977000
4	Cartucho (completo)	92730000
5	Cápsula	96135000
6	Excêntricos esféricos	94140000
7	Emulsor compl.	96429000
8	Inversor compl.	13956000
9	Manípulo do inversor	97978000
10	Válvula anti-retorno	97980000

Português

Marca de controlo

	PA-IX	DVGW	SVGW	KIWA	ACS	NF
31642000	PA-IX 18340/ICB	X	X	X	X	
31643000			X			
31662000	PA-IX 18339/IB	X	X	X	X	
31667000			X			

Falha	Causa	Solução
Água insuficiente	-Filtro do vedante do chuveiro sujo -Válvula anti-retorno está presa	-Limpar o filtro entre o chuveiro e o tubo flexível -Trocar a válvula anti-retorno
Misturadora perra	-Cartucho defeituoso, calcificado	-Substituir o cartucho
Misturadora a pingar	-Cartucho defeituoso	-Substituir o cartucho
Temperatura da água quente muito baixa	-O limitador de temperatura está incorrectamente colocado	-Regular o limitador de temperatura
O esquentador instantâneo não funciona	-O limitador de caudal não foi retirado -Filtro sujo -Válvula anti-retorno está presa	-Retirar o limitador de caudal -Limpar / trocar o filtro -Trocar a válvula anti-retorno

Limitador de água quente: Temperatura da água quente 60 C, Temperatura da água fria 10 C, Pressão 0,3 MPa.

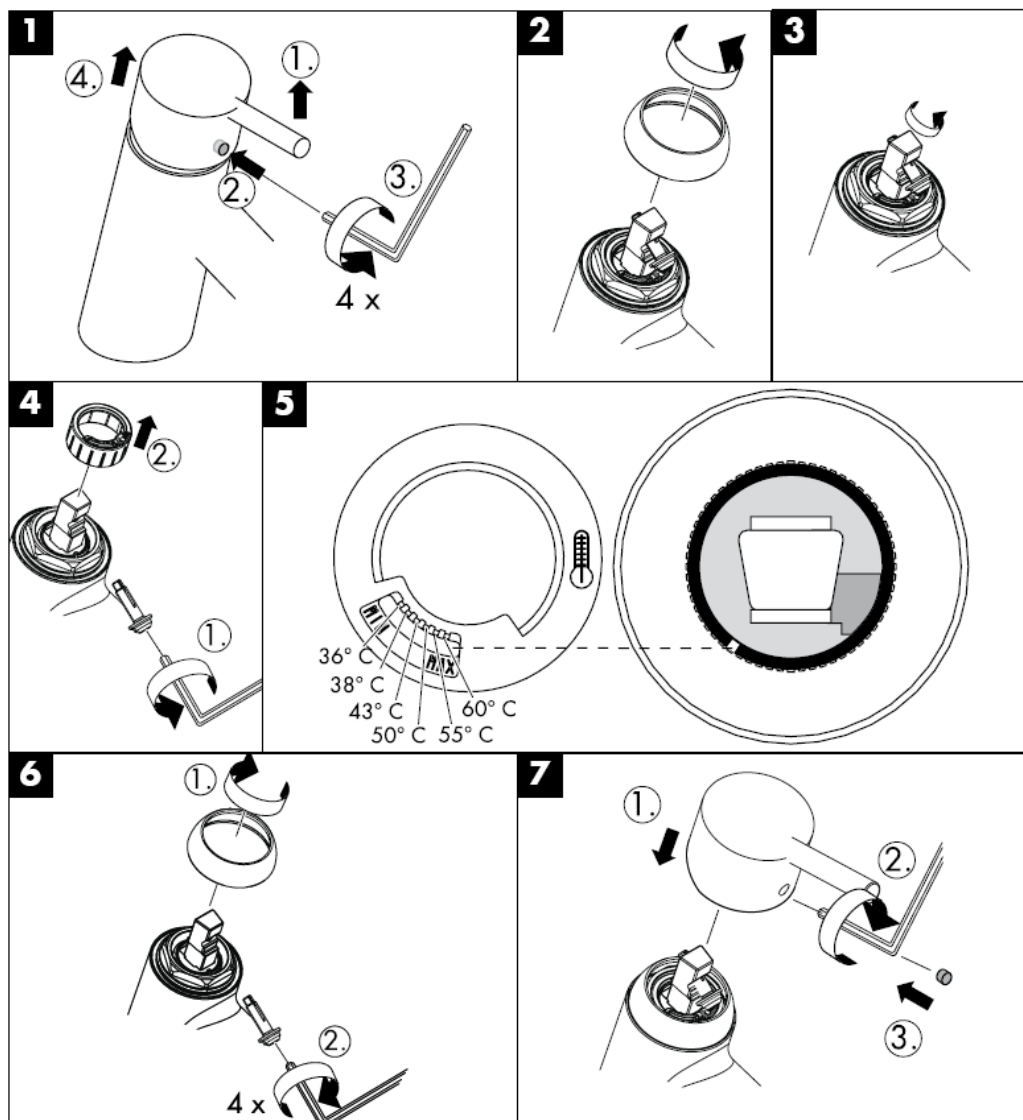

Limpeza

O sistema de limpeza QuickClean requer apenas uma ligeira passagem com a mão para remover os depósitos de calcário do emulsor.

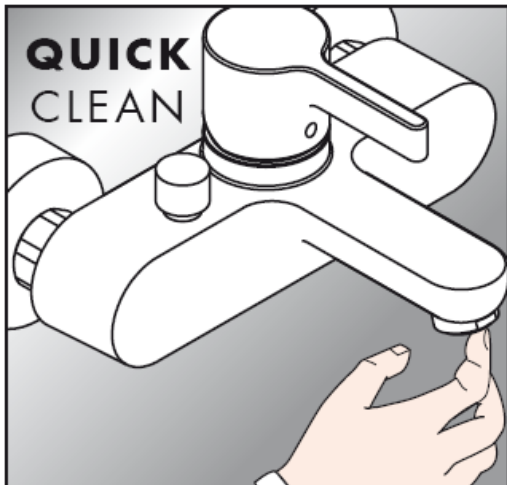

hansgrohe

Hansgrohe · Postfach 1145 · D-77761 Schiltach · Telefon +49 (0) 78 36/51-1282 · Telefax +49 (0) 7836/511440
E-Mail: info@hansgrohe.com · Internet: www.hansgrohe.com

11/2008
9.06851.01
Português

Instrukcja montażu

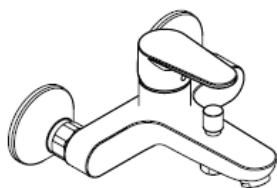

Talis E²
31642000

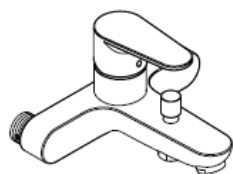

Talis E²
31643000



Talis E²
31662000



Talis E²
31667000

hansgrohe

31642000

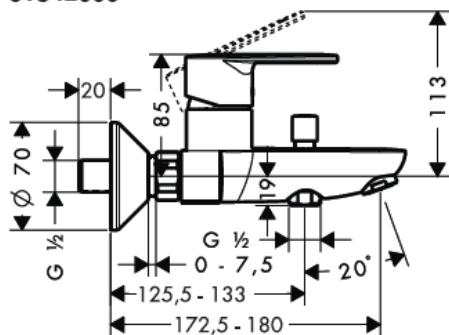

31662000

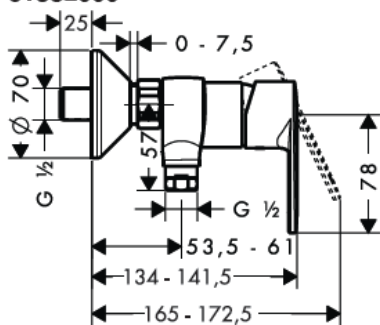

31643000

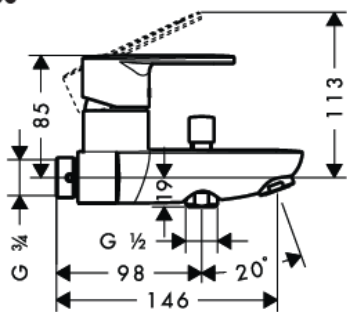

AD 153 mm

31667000

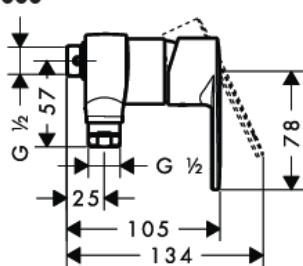

AD 153 mm

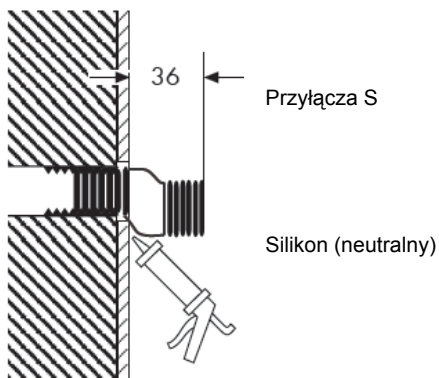



31642000

31662000 / 31667000

31642000 / 31643000



31662000

31643000 / 31667000

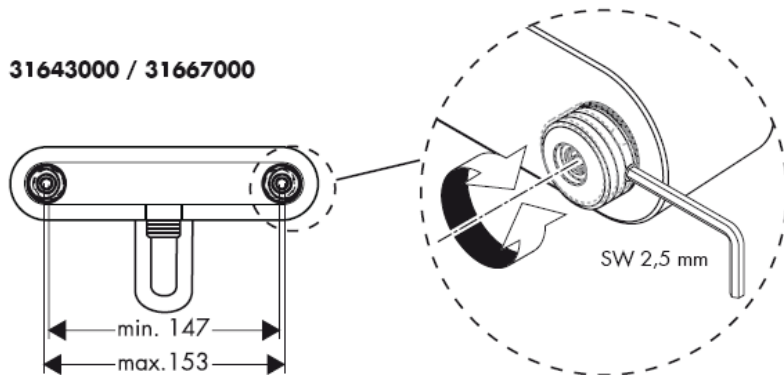

Uwaga! Armatura musi być zamontowana, przepłukana i wypróbowana według obowiązujących norm!

1. Przepłukać instalację
2. Zamocować i nastawić przyłącza S.
3. Dokręcić armaturę z uszczelkami.

Znaczne różnice ciśnień na dopływach ciepłej i zimnej wody muszą zostać wyrównane.

Obsługa

Przez skierowanie uchwyty do góry następuje jego uruchomienie.

Obrót uchwyty w lewo = ciepła woda,

Obrót uchwyty w prawo = zimna woda.

31642000 / 31643000 Przesławienie na przysnic ręczny przez pociągnięcie okrągłego przełącznika przy górnej stronie wylotu. Ustawienie powrotne uzyskuje się automatycznie po zamknięciu rączki natrysku.

Dane techniczne

Ciśnienie robocze: max. 1 MPa

Zalecane ciśnienie robocze: 0,1 – 0,5 MPa

Ciśnienie próbne: 1,6 MPa

(1 MPa = 10 bar = 147 PSI)

Temperatura wody gorącej: max. 80° C

Zalecana temperatura wody gorącej: 65° C

Wymiary przyłącza:

Przyłącza G 1/2": Zimna prawo – ciepła lewo

Wydajność przepływu: ca. 17 l/min 0,3 MPa

Samoistnie zabezpieczony przed przepływem zwrotnym

Mieszacz jednouchwytyowy z ogranicznikiem temperatury wody, ustawianie, patrz str. 6.

W połączeniu z przepływowym podgrzewaczem wody ogranicznik temperatury wody nie jest konieczny.

Mieszacze jednouchwytowe Hansgrohe mogą być stosowane w połączeniu z przepływowymi podgrzewaczami wody, sterowanymi hydraulicznie i termicznie, gdy ciśnienie wody wynosi co najmniej 0,15 MPa.

Uwaga!

Zgodnie z normą DIN 1988 działanie zabezpieczeń przepływu zwrotnego należy skontrolować raz w roku.

Części serwisowe (patrz strona 3)

1	Uchwyt	31692000
1.1	Zaślepka uchwyt	96338000
2	Rozeta kulowa	97406000
3	Nakrętka	97977000
4	Wkład kpl.	92730000
5	Rozeta	96135000
6	Przyłącza S	94140000
7	Napowietrzacz kpl.	96429000
8	Przełącznik kpl.	13956000
9	Łącznik ciągłowy	97978000
10	Zabezpieczenie przed przepływem zwrotnym	97980000

Polski

Znak jakości

	PA-IX	DVGW	SVGW	KIWA	ACS	NF
31642000	PA-IX 18340/ICB	X	X	X	X	
31643000			X			
31662000	PA-IX 18339/IB	X	X	X	X	
31667000			X			

Usterka	Przyczyna	Pomoc
Mała ilość wody	-Zabrudzona uszczelka z sitkiem w prysznicu -Mocno osadzone zabezpieczenie przed przepływem zwrotnym	-Oczyścić uszczelkę z sitkiem pomiędzy prysznicem a wężem -Wymienić zabezpieczenie przed przepływem zwrotnym
Uchwyt armatury pracuje z wysiłkiem	-Uszkodzony wkład, zakamieniony	-Wymiana wkładu
Armatura cieknie	-Uszkodzony wkład	-Wymiana wkładu
Za niska temperatura ciepłej wody	-Niewłaściwe ustawienie ogranicznik ciepłej wody	-Ustawić ogranicznik ciepłej wody
Przepływowy podgrzewacz wody nie załącza się	-Dławik przepływu nie został usunięty z prysznicu ręcznego -Zabrudzone sitka -Mocno osadzone zabezpieczenie przed przepływem zwrotnym	-Usunąć dławik z prysznicu ręcznego -Oczyścić/ wymienić sitka -Wymienić zabezpieczenie przed przepływem zwrotnym

Ogranicznik ciepłej wody: Temperatura ciepłej wody 60 C, temperatura zimnej wody 10 C, ciśnienie przepływu 0,3 MPa.

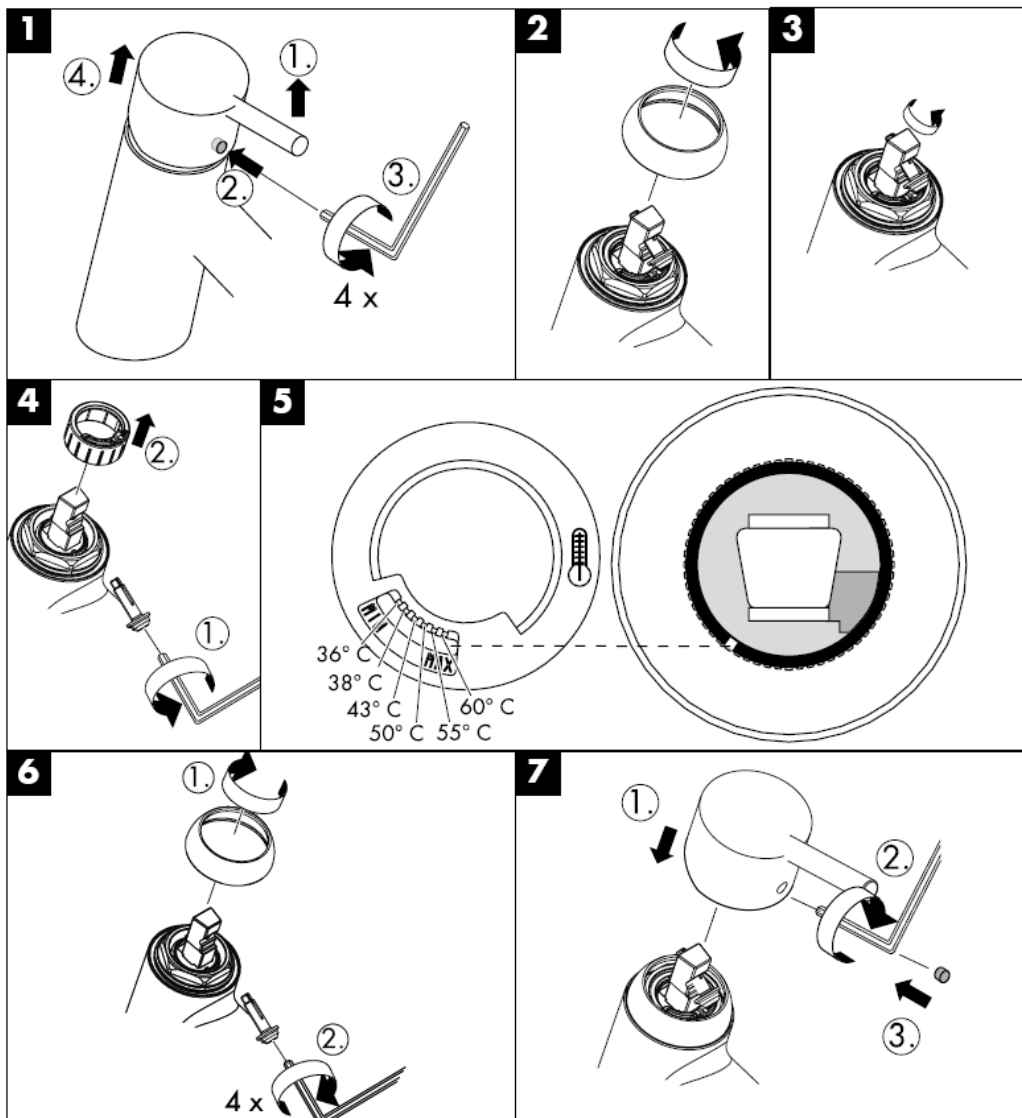

Czyszczenie

Funkcja QuickClean wymaga jedynie delikatnego potarcia dłonią, aby usunąć ewentualne osady kamienia wapiennego.

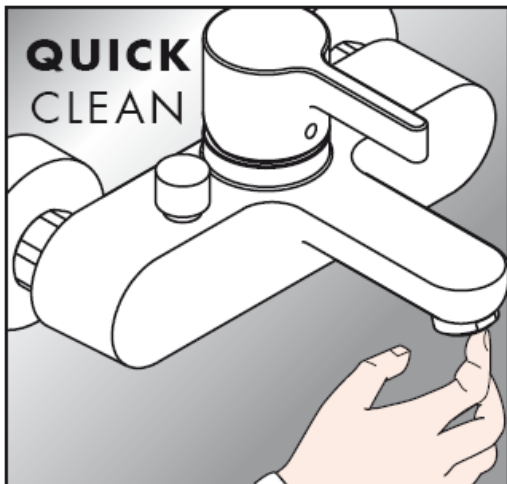

hansgrohe

Hansgrohe · Postfach 1145 · D-77761 Schiltach · Telefon +49 (0) 78 36/51-1282 · Telefax +49 (0) 7836/511440
E-Mail: info@hansgrohe.com · Internet: www.hansgrohe.com

11/2008
9.06851.01
Polski

Montážní návod

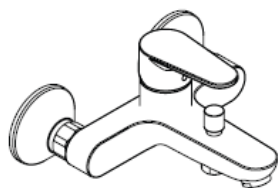

Talis E²
31642000

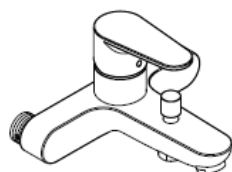

Talis E²
31643000



Talis E²
31662000



Talis E²
31667000

hansgrohe

31642000

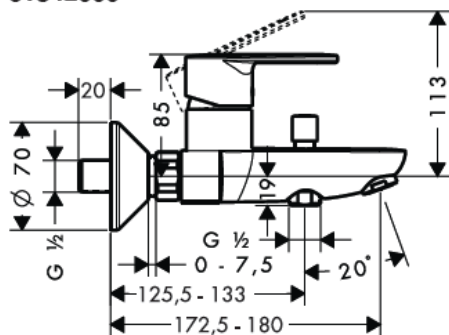

31662000

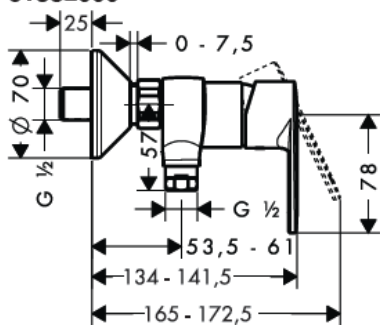

31643000

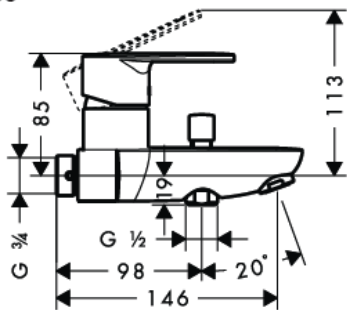

AD 153 mm

31667000

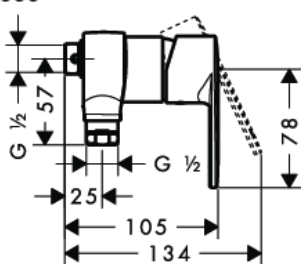

AD 153 mm

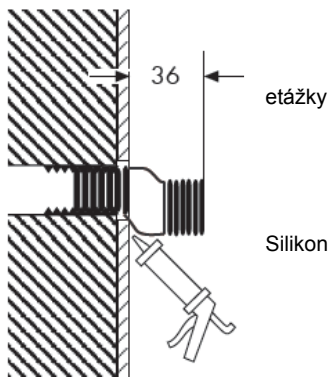



31642000

31662000 / 31667000

31642000 / 31643000



31662000

31643000 / 31667000

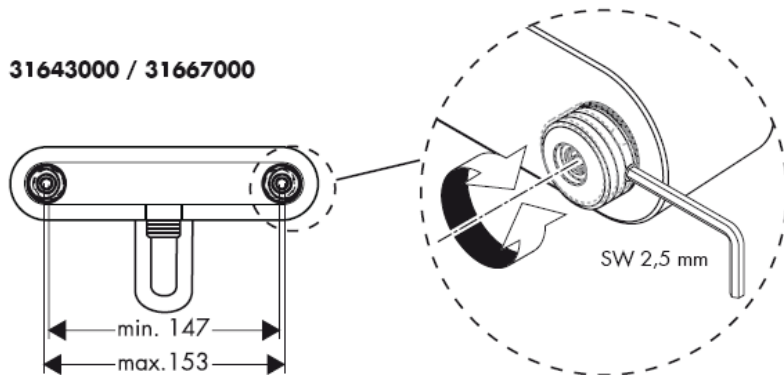

Pozor! Armatura se musí montovat, proplachovat a testovat podle platných norem!

1. Přívodní trubky odborně propláchnout.
2. Namontovat a vyrovnat etážky.
3. Armaturu i s těsněním pevně přišroubovat.

Je nutné vyrovnat velké rozdíly tlaku mezi přípoji studené a teplé vody.

Ovládání

Baterie se otevírá zvednutím rukojeti.

Otočení doleva = teplá voda,

otočení doprava = studená voda.

31642000 / 31643000 Přepnutí na ruční sprchu se provede vytáhnutím kulatého knoflíku na horní straně výtoku. K navrácení dojde automaticky uzavřením rukojeti.

Technické údaje

Provozní tlak: max. 1 MPa

Doporučený provozní tlak: 0,1 – 0,5 MPa

Zkušební tlak: 1,6 MPa

(1 MPa = 10 bar = 147 PSI)

Teplota horké vody: max. 80° C

Doporučená teplota horké vody: 65° C

Rozteč připojení:

Přípoje G 1/2": studená vpravo - teplá vlevo

Průtok: ca. 17 l/min 0,3 MPa

Vlastní jištění proti zpětnému nasátí.

Páková baterie s omezením horké vody, seřízení viz. str. 6.

Ve spojení s průtokovými ohřivači není uzávěr teplé vody nutný.

Pákové baterie Hansgrohe mohou být používány ve spojení s hydraulicky nebo tepelně řízenými průtokovými ohřivači, pokud tlak při průtoku je alespoň 0,15 MPa.

Pozor!

U jištění proti zpětnému nasátí musí být podle normy DIN 1988 jednou ročně přezkoušena jeho funkce.

Servisní díly (viz strana 3)

1	rukojeť	31692000
1.1	krytka šroubu	96338000
2	krytka	97406000
3	matka	97977000
4	kartuše kompl.	92730000
5	rozeta	96135000
6	etážky	94140000
7	perlátor	96429000
8	přepínač kompl.	13956000
9	knoflík táhla	97978000
10	zpečný ventil	97980000

Česky

zkušební značka

	PA-IX	DVGW	SVGW	KIWA	ACS	NF
31642000	PA-IX 18340/ICB	X	X	X	X	
31643000			X			
31662000	PA-IX 18339/IB	X	X	X	X	
31667000			X			

Porucha	Příčina	Odstranění
Málo vody	-Sítko v těsnění u sprchy zanesené -zpětný ventil je zablokován	-Vyčistit sítko v těsnění mezi sprchou a hadicí -Vyměnit zpětný ventil
Armatura jde ztěžka	-Kartuše je vadná, zanesená vodním kamenem	-Kartuši vyměnit
Armatura odkapává	-Kartuše je vadná	-Kartuši vyměnit
nízká teplota teplé vody	-Špatně nastavená zarážka pro teplou vodu	-Seřídít zarážku pro teplou vodu
Průtokový ohříváč nezapíná	-Není odstraněn kroužek ze sprchy -Sítko na zachycování nečistot je zanesené -zpětný ventil je zablokován	-Odstranit kroužek ze sprchy -Vyčistit případně vyměnit sítko -Vyměnit zpětný ventil

Omezení teplé vody: teplota vody (teplé) 60 C, teplota studené vody 10 C, tlak proudu 0,3 MPa.

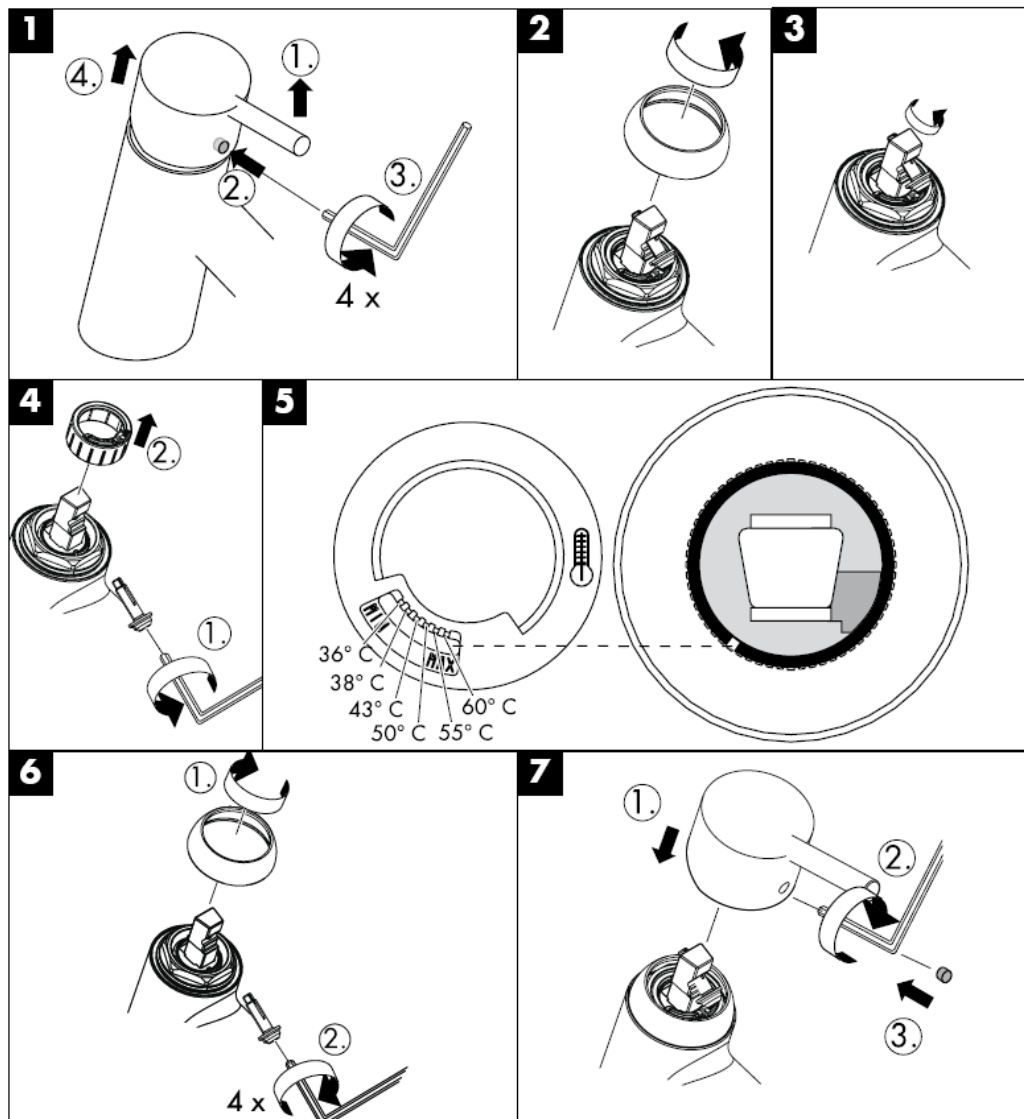

Čištění

S ruční čisticí funkcí QuickClean stačí jednoduché odstranění vodního kamene prsty z trysek kotouče tvarujícího proud vody.



hansgrohe

Hansgrohe · Postfach 1145 · D-77761 Schiltach · Telefon +49 (0) 78 36/51-1282 · Telefax +49 (0) 7836/511440
E-Mail: info@hansgrohe.com · Internet: www.hansgrohe.com

11/2008
9.06851.01
Česky

Montážny návod

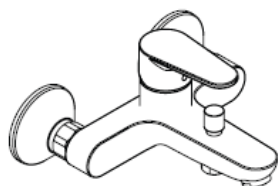

Talis E²
31642000

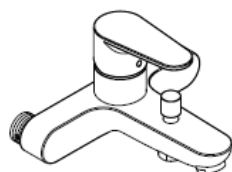

Talis E²
31643000



Talis E²
31662000



Talis E²
31667000

hansgrohe

31642000

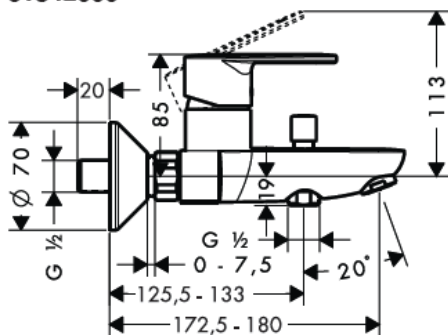

31662000

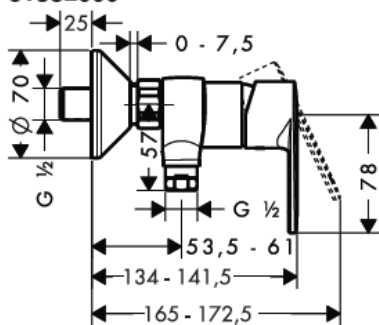

31643000

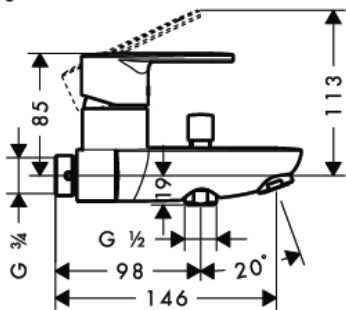

AD 153 mm

31667000

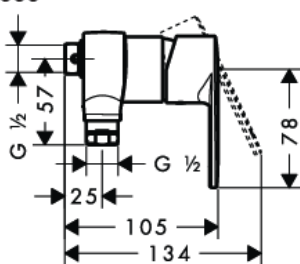

AD 153 mm

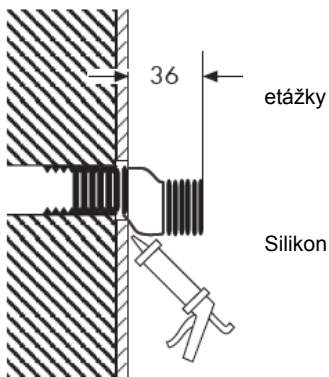



31642000

31662000 / 31667000

31642000 / 31643000



31662000

31643000 / 31667000

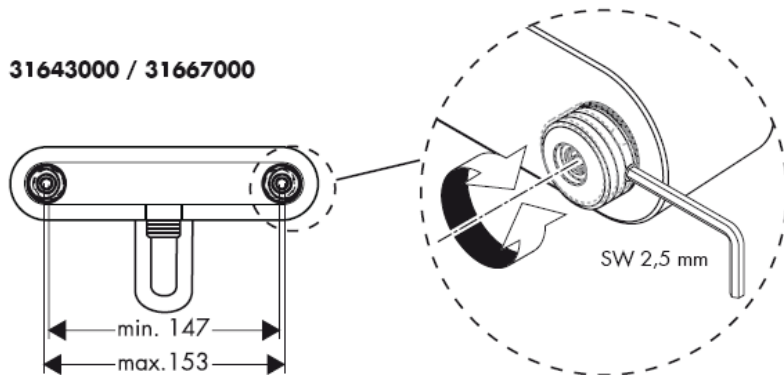

Pozor! Batéria sa musí montovať, preplachovať a testovať podľa platných noriem!

1. Prívodné trubky odborne prepláchnuť.
2. Namontovať a vyrovať etážky.
3. Armatúru s tesnením pevne priskrutkovať.

Veľké rozdiely v tlaku medzi prípojkami studenej a teplej vody musia byť vyrovnané.

Obsluha

Nadvihnutím páky sa zmiešavacia batéria otvorí.

Otočenie páky vľavo = teplá voda.

Otočenie páky vpravo = studená voda.

31642000 / 31643000 Prestavenie na sprchu je možné vytiahnutím kruhového gombíka na hornej strane výstupu vody. Nastavenie späť sa uskutočňuje automaticky po uzavretí páky.

Technické údaje

Prevádzkový tlak: max. 1 MPa

Doporučený prevádzkový tlak: 0,1 – 0,5 MPa

Skúšobný tlak: 1,6 MPa

(1 MPa = 10 bar = 147 PSI)

Teplota teplej vody: max. 80° C

Doporučená teplota teplej vody: 65° C

Prípájacie rozmery:

Prípoje G ½": studená vpravo - teplá vľavo

Prietok: ca. 17 l/min 0,3 MPa

Vlastná poistka proti spätnému nasatiu.

Páková batéria s obmedzením teplej vody, nastavenie vid' str. 6.

V spojení s prietokovými ohrievačmi nie je uzáver teplej vody nutný.

Pákové batérie firmy Hansgrohe môžu byť používané v spojení s hydraulicky a tepelne riadenými prietokovými ohrievačmi, pokiaľ je tlak prúdu aspoň 0,15 MPa.

Pozor!

Pri poistke proti spätnému nasatiu musí byť podľa normy DIN 1988 raz ročne preskúšaná jej funkčnosť.

Servisné diely (vid' strana 3)

1	rukoväť	31692000
1.1	kryt skrutky	96338000
2	krytka	97406000
3	matica	97977000
4	kartuša kompl.	92730000
5	ružica	96135000
6	etážky	94140000
7	perlátor	96429000
8	prepínač kompl.	13956000
9	kryt tiahla	97978000
10	obmedzovač spätného nasatia	97980000

Slovensky

Osvedčenie o skúške

	PA-IX	DVGW	SVGW	KIWA	ACS	NF
31642000	PA-IX 18340/ICB	X	X	X	X	
31643000			X			
31662000	PA-IX 18339/IB	X	X	X	X	
31667000			X			

Porucha	Príčina	Pomoc
Málo vody	-Sitko v tesnení sprchy je znečistené -Obmedzovač spätného nasatia je zablokovaný	-Vyčistiť sitko tesnení medzi sprchou a hadicou -Vymeniť obmedzovač spätného nasatia
Armatúra "chodí" ťažko	-Kartuša je poškodená, vápenaté usadeniny	-Vymeniť kartušu
Armatúra pušča	-Kartuša je poškodená	-Vymeniť kartušu
Nízka teplota teplej vody	-Nesprávne nastavená zarážka na teplú vodu	-Nastavenie zarážky na teplú vodu
Prietokový ohrievač nezapína	-Nie je odstránený krúžok zo sprchy -Sitko v tesnení sprchy je znečistené -Obmedzovač spätného nasatia je zablokovaný	-Odstrániť krúžok zo sprchy -Vyčistiť resp. vymeniť sitko -Vymeniť obmedzovač spätného nasatia

Obmedzenie teplej vody: teplota teplej vody 60 C, teplota studené vody 10 C, tlak prúdu 0,3 MPa.

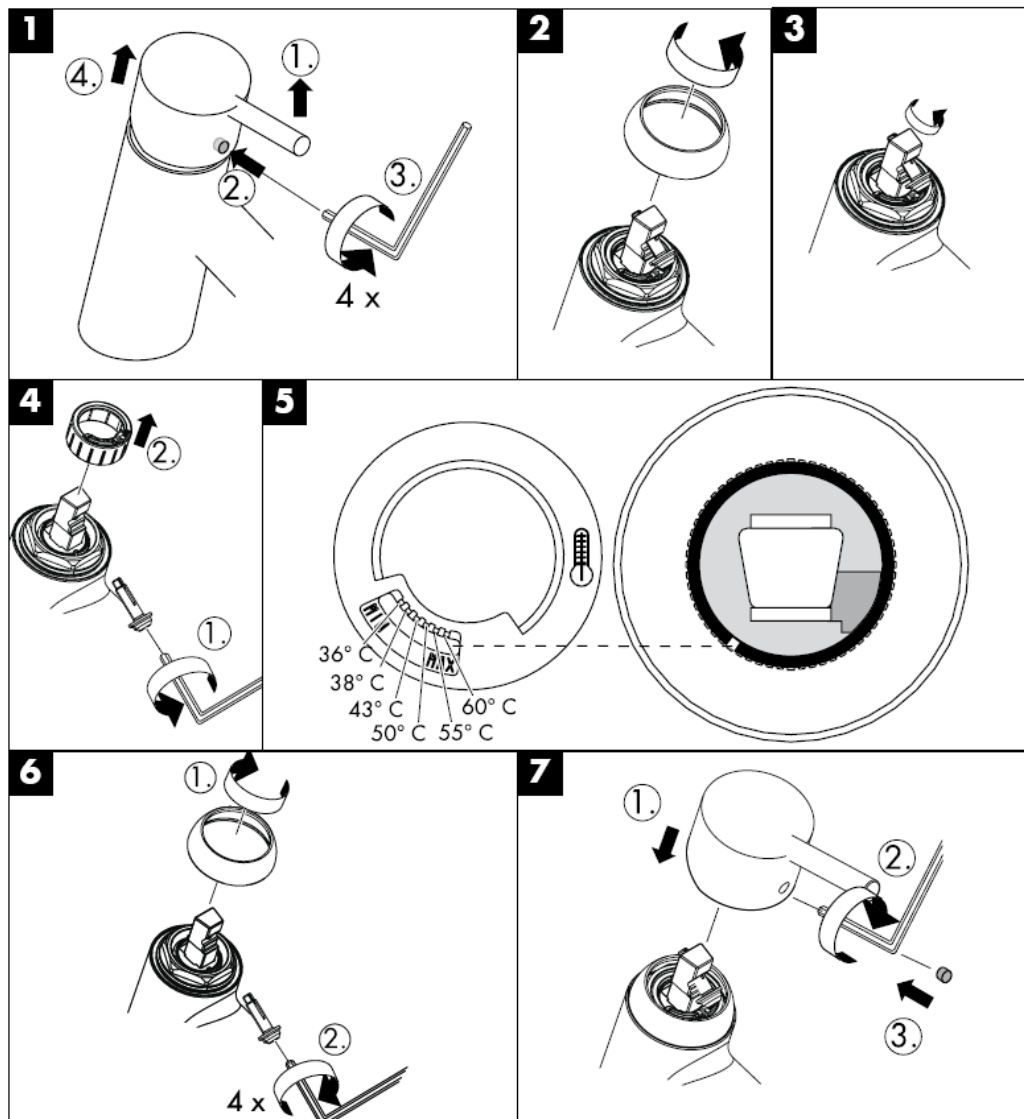

Čištění

Čistiaca funkcia QuickClean, stačí na jednoduché odstránenie vodného kameňa prstami z trysiek kotúča tvarujúceho prúd vody.



hansgrohe

Hansgrohe · Postfach 1145 · D-77761 Schiltach · Telefon +49 (0) 78 36/51-1282 · Telefax +49 (0) 7836/511440
E-Mail: info@hansgrohe.com · Internet: www.hansgrohe.com

11/2008
9.06851.01
Slovensky

组装说明

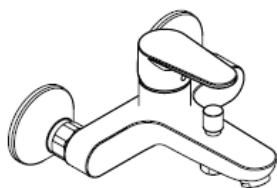

Talis E²
31642000

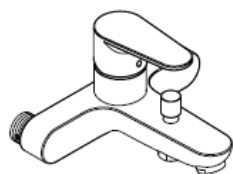

Talis E²
31643000



Talis E²
31662000



Talis E²
31667000

hansgrohe

31642000

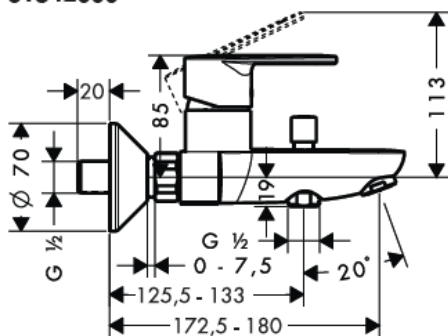

31662000

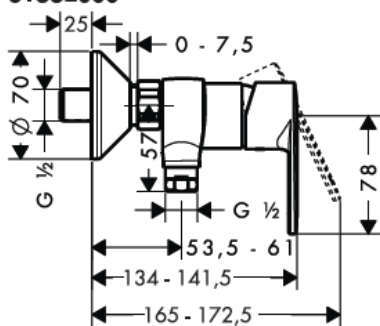

31643000

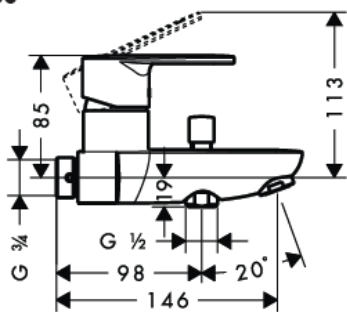

AD 153 mm

31667000

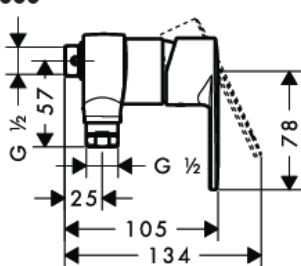

AD 153 mm

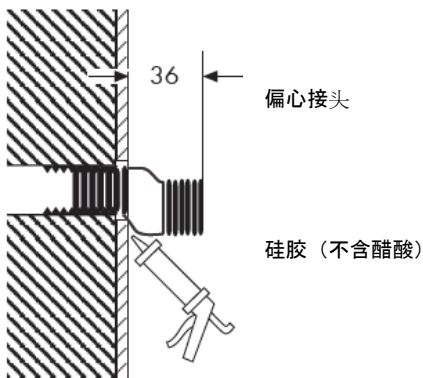



31642000

31662000 / 31667000

31642000 / 31643000



31662000

31643000 / 31667000

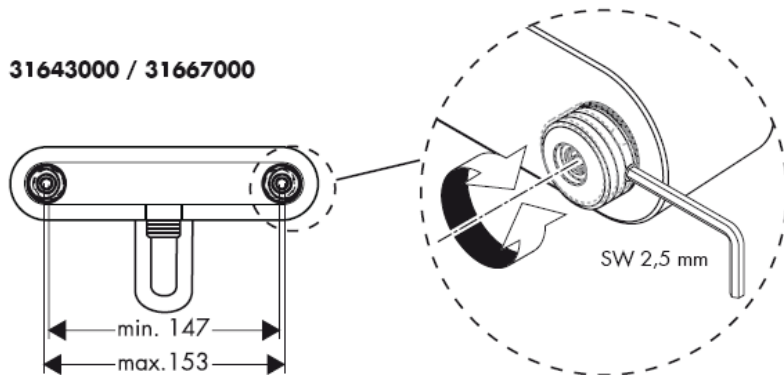

中文

注意！

必须按照现行的规定安装，冲洗和测试产品！

1. 将进水管洗净。
2. 安装S形接头，并对准之。
3. 拧紧龙头及垫圈。

冷热水管间过大的压力差必须予以平衡。

操作

提起手柄，龙头开启。

向左偏转：热水

向右偏转：冷水

31642000 / 31643000

拉动水嘴上边的旋钮，从浴盆向花洒变更水流。关

闭水流后，龙头自动恢复浴盆功能。

技术参数

工作压强：max. 1 MPa

推荐工作压强：0,1 – 0,5 MPa

测试压强：1,6 MPa

(1 MPa = 10 bar = 147 PSI)

热水温度：max. 80° C

推荐热水温度：65° C

中心距离：

连接管线G ½"：左热右冷

流速：ca. 17 l/min 0,3 MPa

自动防止回流

带有热水控制器的单手柄龙头的调节方法，参见第6页。

如果与连续流热水器一起使用，则不必作任何调节。

如果水压达到0,15

MPa以上，汉斯格雅单手柄龙头可以和液压式或热控式直流式热水器一起使用。

注意！

每年必须按照DIN

1988对单向阀的功能进行一次检查。

备用零件 (参见第3页)

1	手柄	31692000
1.1	螺钉帽	96338000
2	法兰	97406000
3	螺母	97977000
4	阀体	92730000
5	法兰	96135000
6	偏心接头	94140000
7	水波器	96429000
8	分水	13956000
9	提拉钮	97978000
10	单向阀	97980000

中文

检验标记

	PA-IX	DVGW	SVGW	KIWA	ACS	NF
31642000	PA-IX 18340/ICB	X	X	X	X	
31643000			X			
31662000	PA-IX 18339/IB	X	X	X	X	
31667000			X			

问题	原因	补救
龙头出水量小	-花洒滤网有垃圾堵塞 -单向阀无法回缩	-清洗花洒和软管间的过滤密封件 -更换单向阀
龙头不灵活	-滤筒损坏，结垢	-更换滤筒
龙头滴水	-滤筒损坏	-更换滤筒
热水温度过低	-热水控制器设置错误	-设置热水控制器
燃气热水器不工作	-手持花洒的流量限制器没有转动 -过滤网有垃圾堵塞 -单向阀无法回缩	-转动流量限制器 -清洗过滤网/更换过滤网 -更换单向阀

热水限制：热水温度60 C，冷水温度10 C，流动压力0,3 Mpa

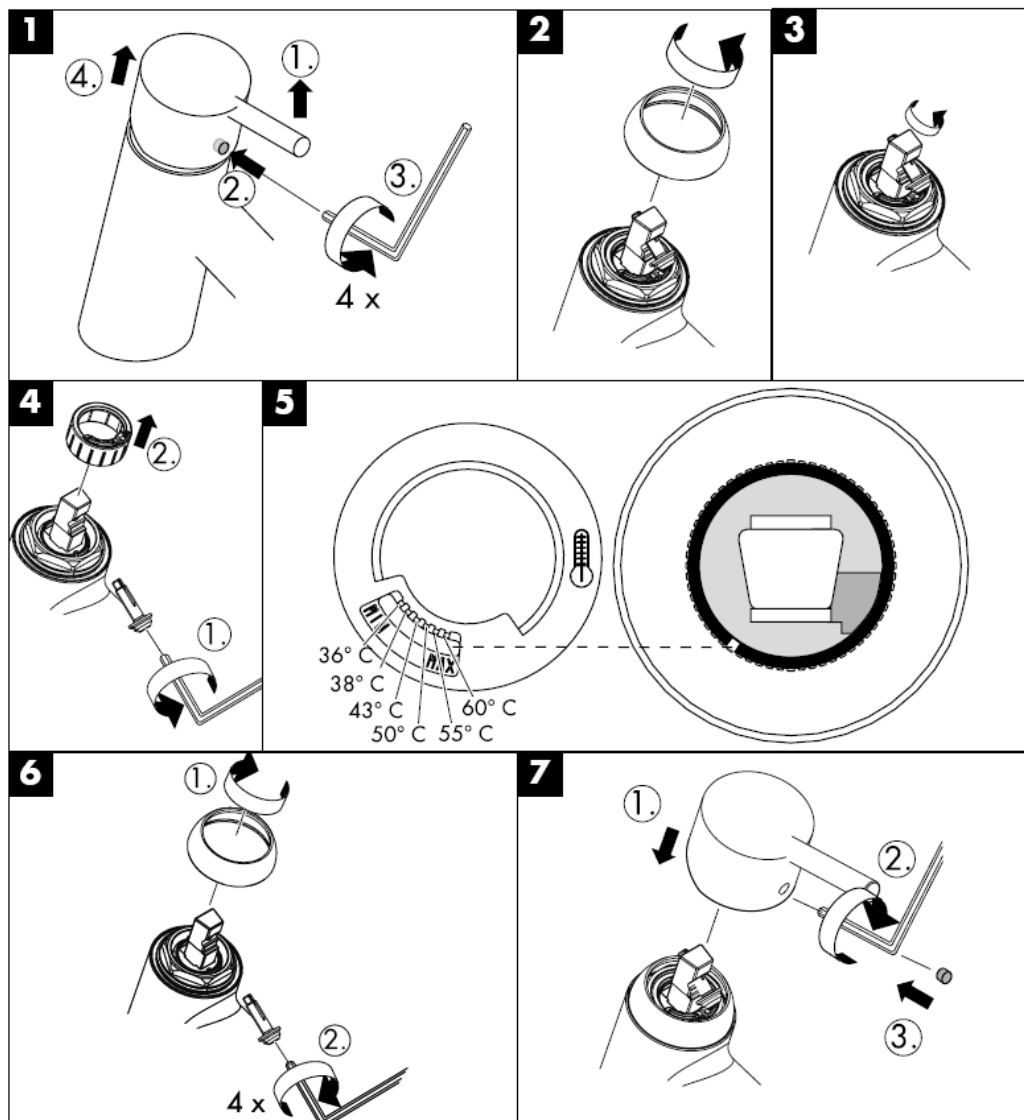

清洗

有了QuickClean，手工清洁功能，要去除喷头上的水垢，只需简单地搓除即可。

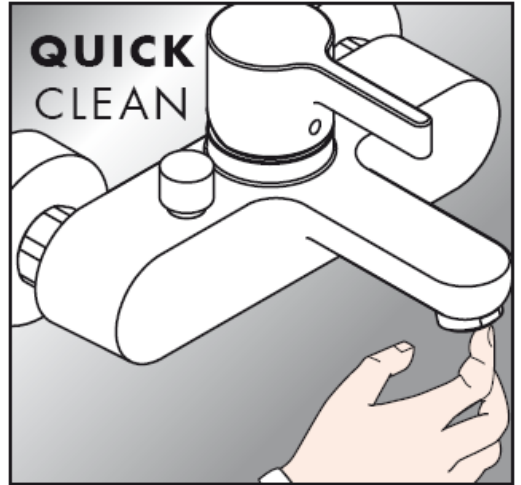

hansgrohe

Hansgrohe · Postfach 1145 · D-77761 Schiltach · Telefon +49 (0) 78 36/51-1282 · Telefax +49 (0) 7836/511440
E-Mail: info@hansgrohe.com · Internet: www.hansgrohe.com

11/2008
9.06851.01
中文

Инструкция по монтажу

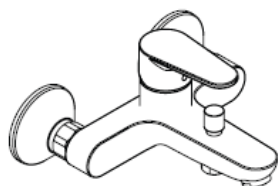

Talis E²
31642000

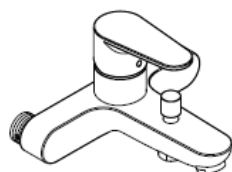

Talis E²
31643000



Talis E²
31662000



Talis E²
31667000

hansgrohe

31642000

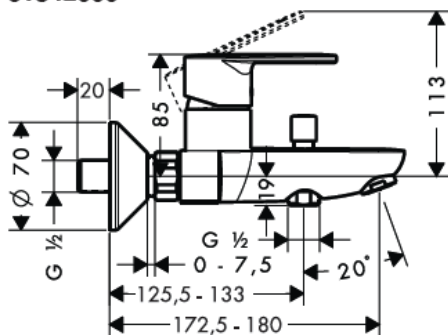

31662000

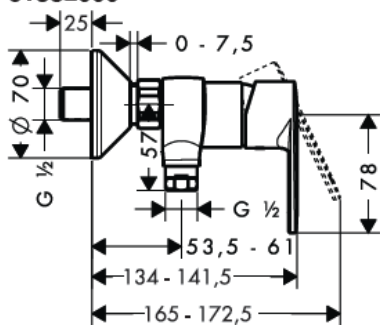

31643000

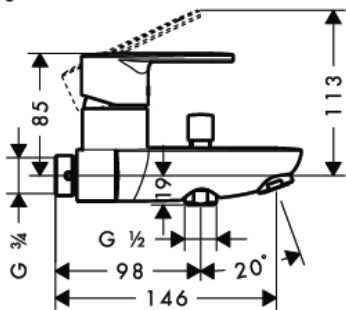

AD 153 mm

31667000

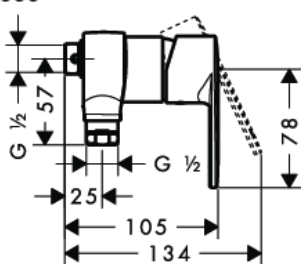

AD 153 mm

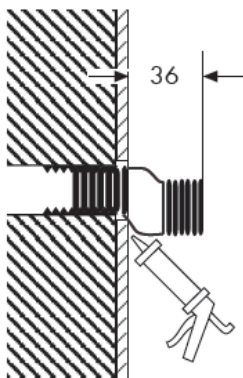

S-образные подключения

Силикон (не содержит уксусной кислоты!)



31642000

31662000 / 31667000

31642000 / 31643000



31662000

31643000 / 31667000

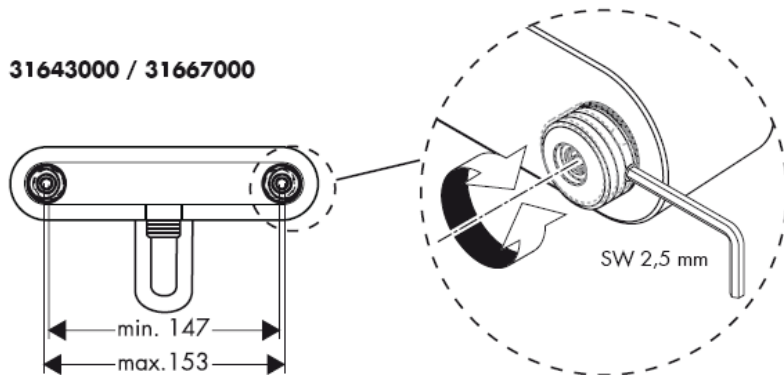

ВНИМАНИЕ! Смеситель должен быть смонтирован по действующим нормам и в соответствии с настоящей инструкцией, проверен на герметичность и безупречность работы

1. тщательно промыть водопроводные трубы, спустив некоторое количество воды;
2. Установите и выровняйте S-образные подключения
3. Затяните смеситель с уплотнениями.

донного клапа. Перед установкой смесителя необходимо регулировочными кранами выровнять давление холодной и горячей воды при помощи вентилей регулирующих подачу воды в квартиру.

Эксплуатация

смеситель открывается поднятием рычага. Поворот рычага налево открывает горячую воду; поворот рычага направо открывает холодную воду.

31642000 / 31643000 Переключение на ручной душ вытягиванием круглой кнопки с верхней стороны выхода. Переключение в исходное положение осуществляется автоматически после закрытия рукоятки.

Технические данные

Рабочее давление: max. 1 МПа
Рекомендуемое рабочее давление: 0,1 – 0,5 МПа
Давления: 1,6 МПа
(1 МПа = 10 bar = 147 PSI)
Температура горячей воды: max. 80° С
Рекомендуемая темп. гор. воды: 65° С
Размеры подключения:
Подключение G 1/2": холодная справа
горячая слева
Пропускная способность: ca. 17 л/мин 0,3 МПа
укомплектован клапаном обратного тока воды

Однорычажный смеситель имеет ограничитель расхода горячей воды (см. Стр. 6: юстировка).

Однорычажные смесители фирмы HANSGROHE можно использовать с электроводонагревателями бойлерного типа при минимальном давлении 0,15 МПа.

ВНИМАНИЕ!

клапан обратного тока воды должен проверяться не реже одного раза в год

Комплект (см. стр. 3)

1	Рукоятка	31692000
1.1	Пробка декоративная	96338000
2	Сферический колпачок	97406000
3	Гайка	97977000
4	Картридж	92730000
5	Розетка	96135000
6	S-образные подключения	94140000
7	Аэратор	96429000
8	Переключатель режима	13956000
9	Кнопка переключателя	97978000
10	Защита обратного тока воды	97980000

Русский

Знак технического контроля

	PA-IX	DVGW	SVGW	KIWA	ACS	NF
31642000	PA-IX 18340/ICB	X	X	X	X	
31643000			X			
31662000	PA-IX 18339/IB	X	X	X	X	
31667000			X			

Неисправность	Причина	Устранение неисправности
недостаточный давление (если устан напор воды)	-Фильтр душа загрязнен -Клапан обратного тока заедает	-Очистить фильтр -Замените клапаны обратного течения
Арматура работает с усилием	-Картридж неисправен, засорение накипью	-Замените картридж
Арматура протекает	-Картридж неисправен	-Замените картридж
Температура горячей воды слишком низкая	-Ограничение горячей воды отрегулировано неправильно	-Отрегулируйте ограничение горячей воды
Проточный нагреватель не включается	-Дроссель не удален из ручного душа -Грязеулавливающие сита загрязнены -Клапан обратного тока заедает	-Извлеките дроссель из ручного душа -Очистите / замените грязеулавливающие сита -Замените клапаны обратного течения

Ограничение расхода горячей воды: температура горячей воды 60 С, температура холодной воды 10 С, давление 0,3 МПа.

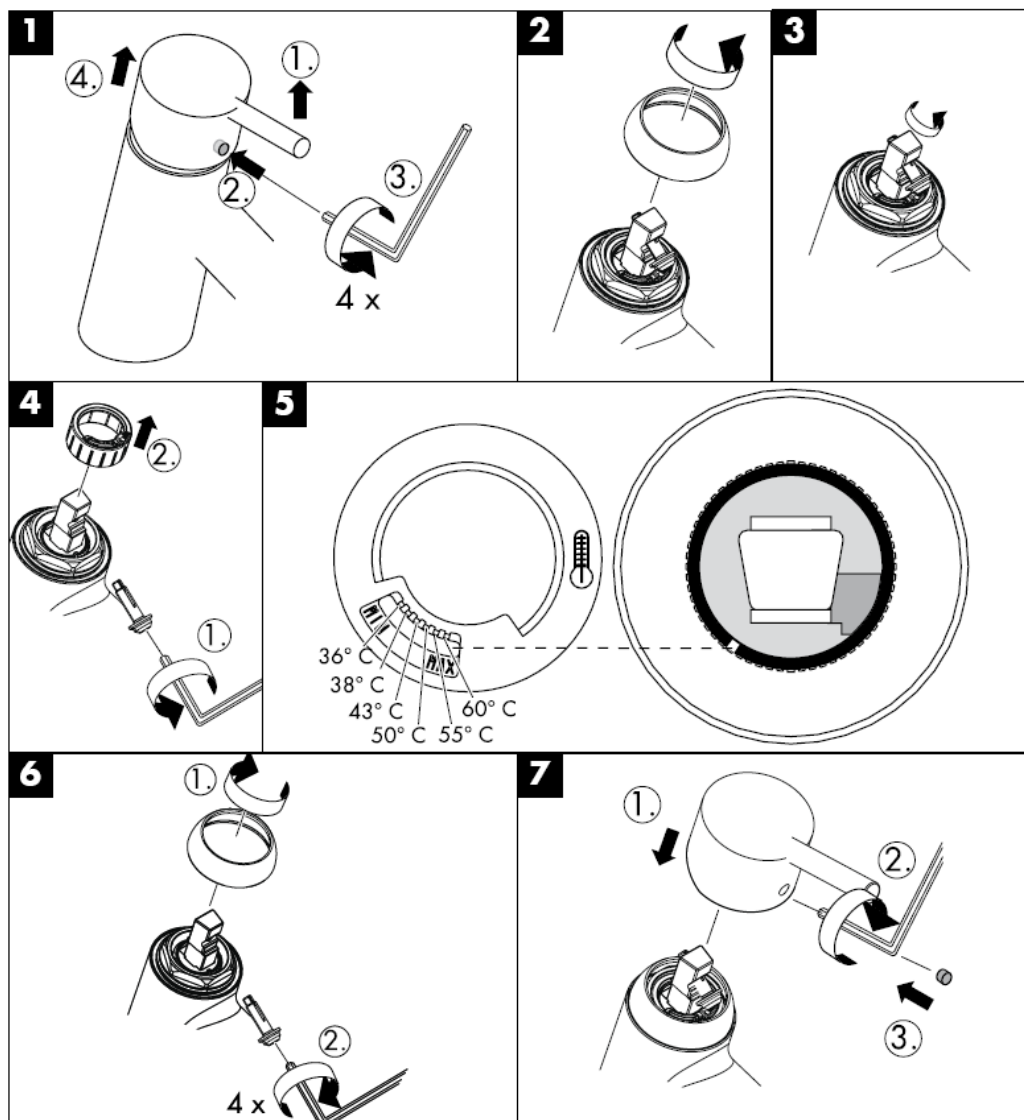

Очистка

система QuickClean позволяет удалять известковые отложения, достаточно провести по эластичной поверхности аэратора пальцем, как известковые отложения будут удалены.



hansgrohe

Hansgrohe · Postfach 1145 · D-77761 Schiltach · Telefon +49 (0) 78 36/51-1282 · Telefax +49 (0) 7836/511440
E-Mail: info@hansgrohe.com · Internet: www.hansgrohe.com

11/2008
9.06851.01
Русский

Szerelési útmutató

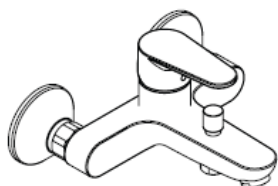

Talis E²
31642000

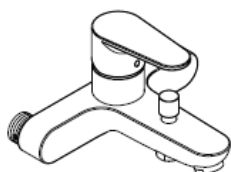

Talis E²
31643000

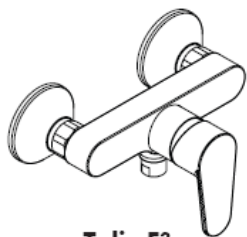

Talis E²
31662000



Talis E²
31667000

hansgrohe

31642000

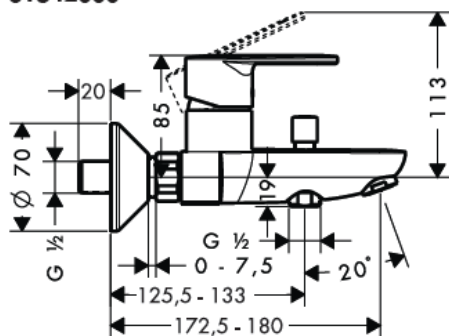

31662000

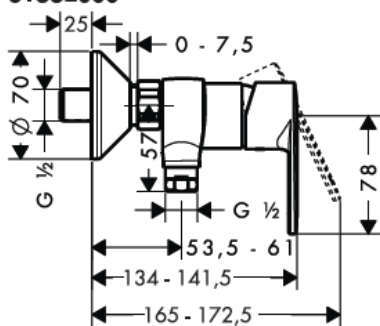

31643000

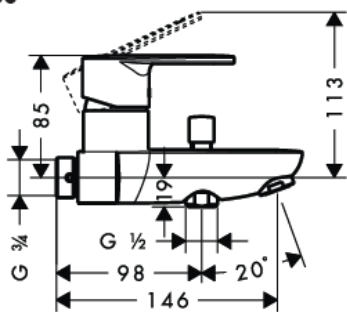

AD 153 mm

31667000

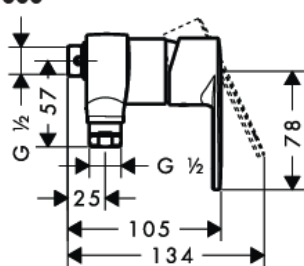

AD 153 mm

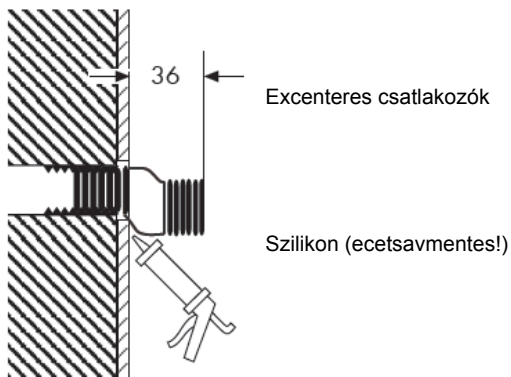



31642000

31662000 / 31667000

31642000 / 31643000



31662000

31643000 / 31667000

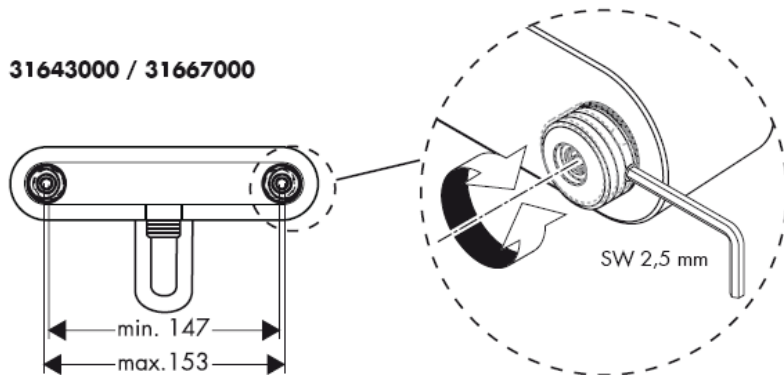

Figyelem! A csaptelepet az érvényben lévő előírásoknak megfelelően kell felszerelni, átöblíteni és ellenőrizni!

1. A vezetékeket gondosan átöblítjük.
2. Az Z-csatlakozásokat összeszereljük és beállítjuk.
3. A tömítéseket beillesztjük, a csapot összecsavarjuk.

A hidegvíz- és a melegvíz-csatlakozások közötti nagy nyomáskülönbséget kikell egyenlíteni!

Használat

A keverőcsapot a fogantyú emelésével nyitjuk ki. Balra csavarva meleg víz, jobbra csavarva hideg víz folyik.
31642000 / 31643000 A kézi zuhanyra történő átállítás a kifolyó felső részén lévő kerek gomb húzásával történik. A visszaállítás a fogantyú elzárása után automatikusan bekövetkezik.

Műszaki adatok

Üzemi nyomás: max. 1 MPa
Ajánlott üzemi nyomás: 0,1 – 0,5 MPa
Nyomáspróba: 1,6 MPa
(1 MPa = 10 bar = 147 PSI)
Forróvíz hőmérséklet: max. 80° C
Forróvíz javasolt hőmérséklete: 65° C
Csatlakozási méret:
G ½" csatlakozás: hideg jobbra – meleg balra
Átfolyási teljesítmény : ca. 17 l/min 0,3 MPa
Visszafolyás gátlóval

Az egykaros, melegvíz-korlátozóval ellátott keverő csaptelep beállítását lásd a 6. oldalon.

Az átfolyó rendszerű vízmelegítőknél nem szükséges a melegvíz-korlátozó.

A Hansgrohe egykaros keverő csaptelepek beépíthetők hidraulikus- és hőszabályozással ellátott átfolyós vízmelegítőknél egyaránt, ha a víznyomás legalább 0,15 MPa.

Figyelem!

A visszafolyásgátlók működését a DIN 1988 szerint évente egyszer ellenőrizni kell.

Tartozékok (lásd a 3. oldalon)

1	Fogantyú	31692000
1.1	Takaródugó a csavarhoz	96338000
2	Golyórozetta	97406000
3	Anya	97977000
4	Betét	92730000
5	Rozetta	96135000
6	Excenteres csatlakozók	94140000
7	Perlátor	96429000
8	kádváltó szelep (kompl.)	13956000
9	kádváltó szelep gomb	97978000
10	Visszacsapószelep	97980000

Magyar

Vizsgajel

	PA-IX	DVGW	SVGW	KIWA	ACS	NF
31642000	PA-IX 18340/ICB	X	X	X	X	
31643000			X			
31662000	PA-IX 18339/IB	X	X	X	X	
31667000			X			

Hiba	Ok	Megoldás
Kevés víz	-a zuhany szűrőtömitése koszos -A visszafolyásgátló beragadt.	-a zuhany és a cső közötti szűrőt ki kell tisztítani -A visszafolyásgátló kicserélése javasolt.
Nehezen nyitható a csap.	-A kerámiabetét meghibásodott, elvízkövesedett.	-A kerámiabetétet ki kell cserélni.
Csöpög a csap. túl alacsony melegvíz hőmérséklet	-A kerámiabetét meghibásodott. -A melegvíz szabályozó rosszul van beállítva.	-A kerámiabetétet ki kell cserélni. -A melegvíz szabályozót újra be kell állítani.
Az átfolyós vízmelegítő nem kapcsol be.	-Nincs kiszerve a zuhanyrózsából a vízmennyiség szabályozó. -A szennyfogó szűrő koszos. -A visszafolyásgátló beragadt.	-El kell távolítani a vízmennyiség szabályozót. -A szennyfogó szűrőt tisztítani/cserélni kell. -A visszafolyásgátló kicserélése javasolt.

Melegvíz-korlátozás: melegvíz-hőmérséklet 60 C, hidegvíz-hőmérséklet 10 C, víznyomás 0,3 MPa.

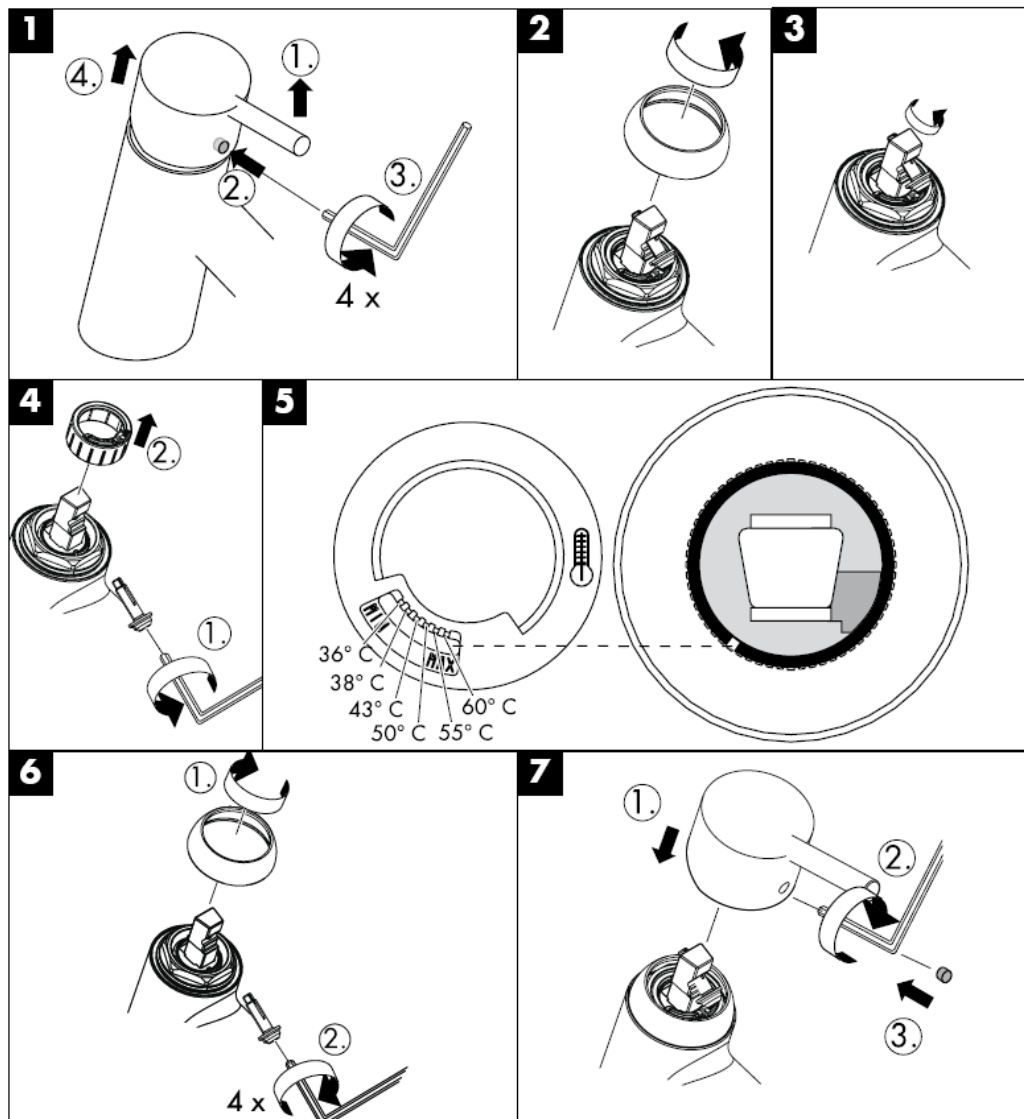

Tisztítás

A QuickClean manuális tisztítófunkciónak köszönhetően a vízszugárnyílások egyszerű ledörzsöléssel megtisztíthatóak a vízkőtől.

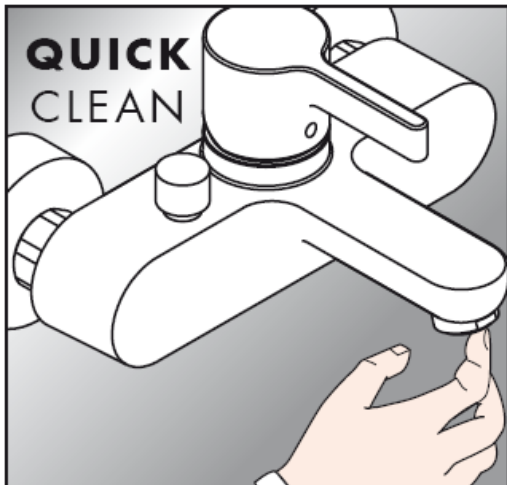

hansgrohe

Hansgrohe · Postfach 1145 · D-77761 Schiltach · Telefon +49 (0) 78 36/51-1282 · Telefax +49 (0) 7836/511440
E-Mail: info@hansgrohe.com · Internet: www.hansgrohe.com

11/2008
9.06851.01
Magyar

Asennusohje

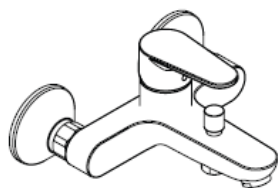

Talis E²
31642000

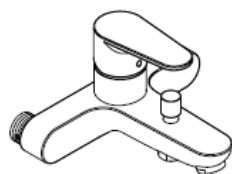

Talis E²
31643000



Talis E²
31662000



Talis E²
31667000

hansgrohe

31642000

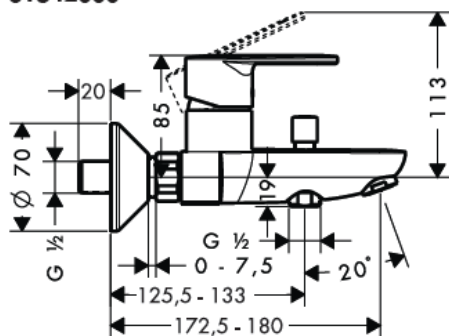

31662000

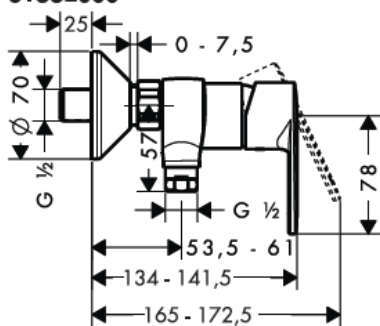

31643000

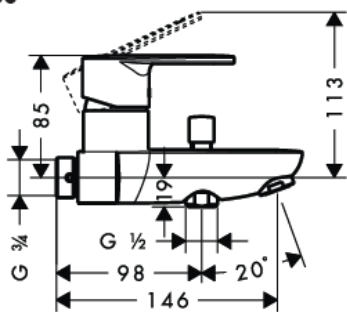

AD 153 mm

31667000

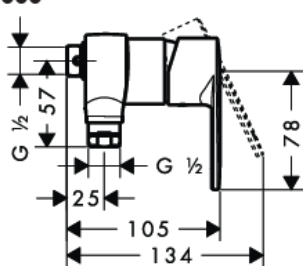

AD 153 mm

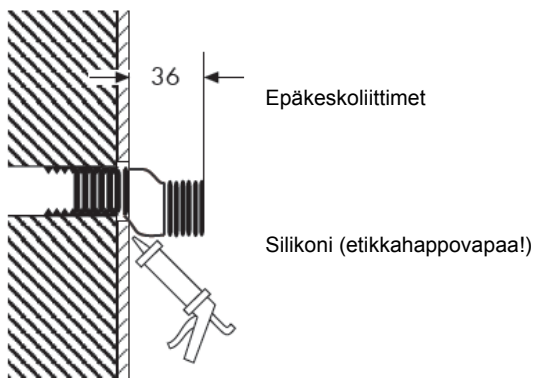



31642000

31662000 / 31667000

31642000 / 31643000



31662000

31643000 / 31667000

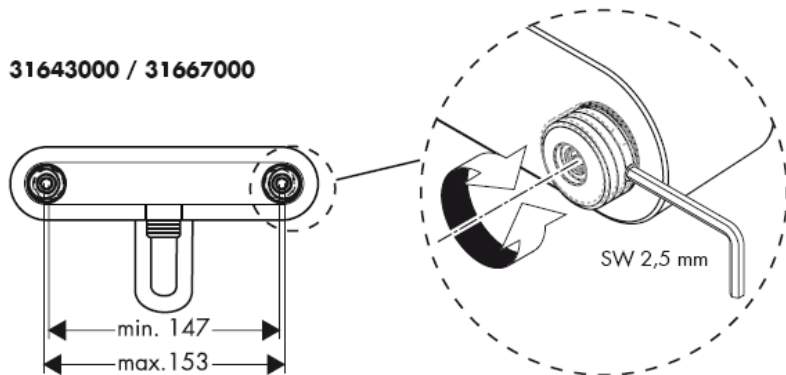

Huomio! Kaluste on asennettava, huuhdeltava ja tarkastettava voimassa olevien määräysten mukaisesti!

1. Huuhtelee syöttöputken asianmukaisesti.
2. Asenna ja suuntaa epäkeskoliittimet
3. Kiinnitä kalusteet tiivisteitä käyttäen.

Suuret paine-erot kylmä- ja kuumavesiliitäntöjen välillä on tasattava.

Käyttö

Sekoittaja avataan kahvaa nostamalla.

Kääntö oikealle = kylmä vesi,

kääntö vasemmalle = lämmin vesi.

31642000 / 31643000 Käsisuihkulle vaihtaminen tehdään juoksuputken yläpuolella olevasta, pyöreästä nupista vetämällä. Palautus tapahtuu automaattisesti kahvan sulkemisen jälkeen.

Tekniset tiedot

Käyttöpaine: max. 1 MPa

Suosittelut käyttöpaine: 0,1 – 0,5 MPa

Koestuspaine: 1,6 MPa

(1 MPa = 10 bar = 147 PSI)

Kuuman veden lämpötila: max. 80° C

Kuuman veden suosituslämpötila: 65° C

Liitäntämitat:

Liittimet G ½" kylmä oikealla - kuuma vasemmalla

Läpivirtausmäärä: ca. 17 l/min 0,3 MPa

Estää itsestään paluuvirtauksen

Yksivipuinen sekoittaja lämpimän veden rajoituksella, katso säätö sivulta 6. Lämpimän veden rajoitusta ei tarvita läpivirtauskuumentimen yhteydessä.

Hansgrohe yksivipuisia sekoittimia voi käyttää hydraulisesti tai termisesti ohjattujen läpivirtauskuumentimien yhteydessä, jos virtauspaine on vähintään 0,15 MPa.

Huomio!

Vastaventtiilin toiminta on normin DIN 1988 mukaan tarkastettava vuosittaan.

Varaosat (katso sivu 3)

1	Kahva	31692000
1.1	Kahvatulppa	96338000
2	Suojakuppi	97406000
3	Mutteri	97977000
4	Panos, täydellinen	92730000
5	Peitekaulus	96135000
6	Epäkeskoliittimet	94140000
7	Poresuutin, täydellinen	96429000
8	Vaihtoventtiili, täydellinen	13956000
9	Vetonuppi	97978000
10	Vastaventtiili	97980000

Suomi

Koestusmerkki

	PA-IX	DVGW	SVGW	KIWA	ACS	NF
31642000	PA-IX 18340/ICB	X	X	X	X	
31643000			X			
31662000	PA-IX 18339/IB	X	X	X	X	
31667000			X			

Häiriö	Syy	Toimenpide
Vähän vettä	-Käsisiuhkun sihttiiviste likaantunut -Suuntaisventtiili juuttunut	-Puhdista suihkukahvan ja letkun välissä oleva sihttiiviste -Vaihda suuntaisventtiili
Hana on raskaskäyttöinen	-Patruuna rikki, kalkkikerrostumia	-Vaihda patruuna
Hanasta tippuu vettä	-Patruuna rikki	-Vaihda patruuna
Lämminveden lämpötila liian alhainen	-Lämminveden rajoitin väärin säädetty	-Säädä lämminveden rajoitin
Läpimenokuumennin ei kytkeydy päälle	-Käsisiuhkussa olevaa kuristinta ei ole poistettu -Likasihdit likaantuneet -Suuntaisventtiili juuttunut	-Poista kuristin käsisiuhkusta -Puhdista / vaihda likasihdit -Vaihda suuntaisventtiili

Kuuman veden rajoitin: kuuman veden lämpötila 60 C, kylmän veden lämpötila 10 C, virtauspaine 0,3 MPa.

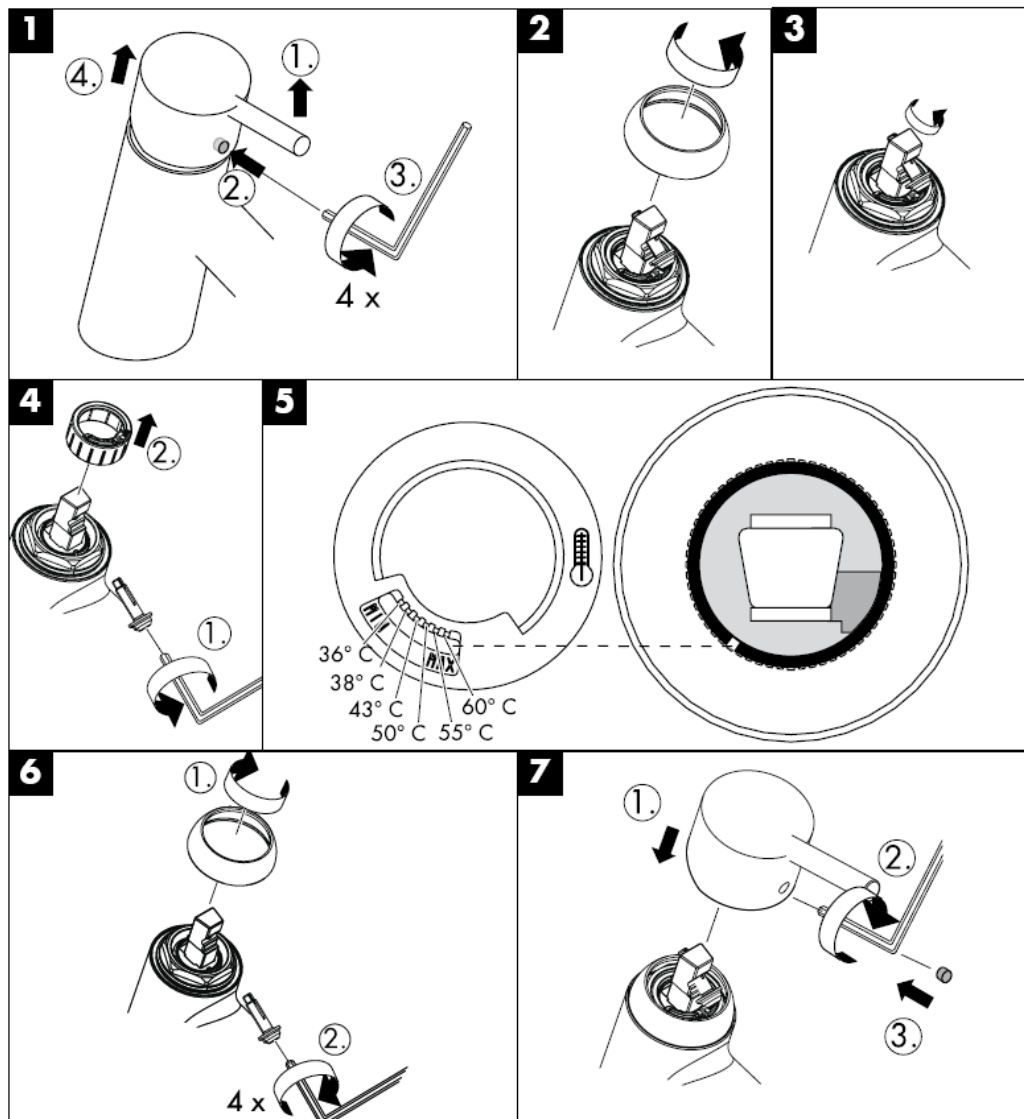

Puhdistus

QuickClean –käsitoiminen kalkinpoistojärjestelmä on helppo käyttää: hiero sormella ja vedentulo on taas esteetön.

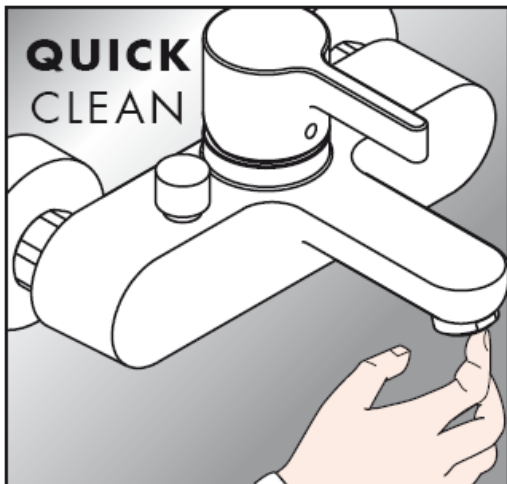

hansgrohe

Hansgrohe · Postfach 1145 · D-77761 Schiltach · Telefon +49 (0) 78 36/51-1282 · Telefax +49 (0) 7836/511440
E-Mail: info@hansgrohe.com · Internet: www.hansgrohe.com

11/2008
9.06851.01
Suomi

Monteringsanvisning

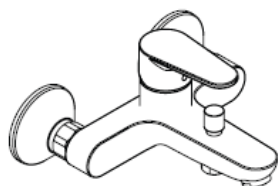

Talis E²
31642000

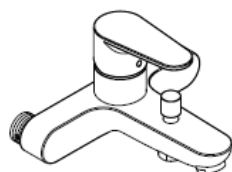

Talis E²
31643000



Talis E²
31662000



Talis E²
31667000

hansgrohe

31642000

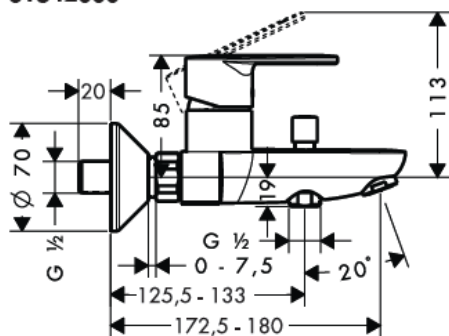

31662000

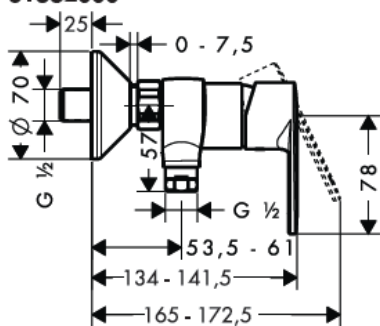

31643000

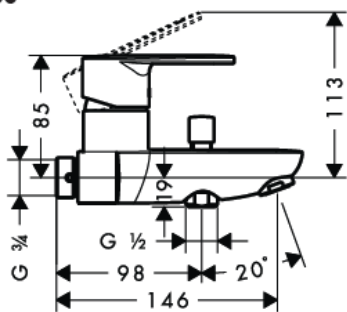

AD 153 mm

31667000

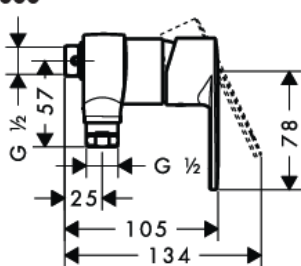

AD 153 mm

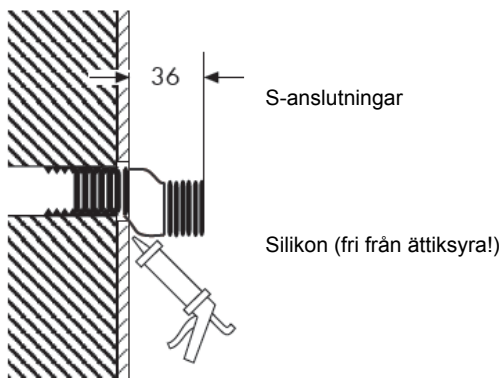



31642000

31662000 / 31667000

31642000 / 31643000



31662000

31643000 / 31667000

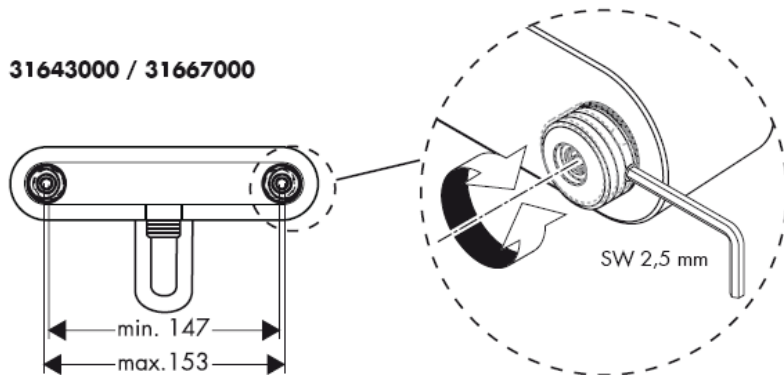

OBS! Blandaren måste installeras, genomspolas och testas enligt gällande föreskrifter.

1. Skölj tillförselledningarna noga.
2. Montera och rikta in S-anslutningar.
3. Skruva fast blandaren med packningar.

Stora tryckskillnader mellan anslutningarna för varmt och kallt vatten måste utjämnas.

Hantering

Genom att lyfta på greppet öppnas blandaren.
Sväng till höger = varmt vatten
Sväng till vänster = kallt vatten
31642000 / 31643000 Man ställer om till handdusch genom att dra i den runda knappen på översidan av blandaren. Återställningen sker automatiskt när greppet har stängts.

Tekniska data

Driftstryck: max. 1 MPa
Rek. driftstryck: 0,1 – 0,5 MPa
Tryck vid provtryckning: 1,6 MPa
(1 MPa = 10 bar = 147 PSI)
Varmvattentemperatur: max. 80° C
Rek. varmvattentemp.: 65° C
Anslutningsmått:
Anslutningar G ½": kallt höger – varmt vänster
Genomströmningmängd: ca. 17 l/min 0,3 MPa
Självspärr mot återflöde

Enhandsblandare med varmvattenreglering, justering se sidan 6. Vid användning tillsammans med varmvattenberedare behövs ingen varmvattenreglering.

Hansgrohe enhandsblandare kan användas tillsammans med hydrauliskt och termiskt styrda varmvattenberedare när flödestrycket uppgår till minst 0,15 MPa.

OBS!

Backventilernas funktion måste kontrolleras en gång varje år enligt DIN 1988.

Reservdelar (se sidan 3)

1	Grepp	31692000
1.1	Greppstopp	96338000
2	Skydd	97406000
3	Mutter	97977000
4	Patron kompl.	92730000
5	Rosett	96135000
6	S-anslutningar	94140000
7	Komplett perlator	96429000
8	Omställare kompl.	13956000
9	Dragknapp	97978000
10	Backventil	97980000

Svenska

Testsigill

	PA-IX	DVGW	SVGW	KIWA	ACS	NF
31642000	PA-IX 18340/ICB	X	X	X	X	
31643000			X			
31662000	PA-IX 18339/IB	X	X	X	X	
31667000			X			

Störning	Orsak	Åtgärd
För lite vatten	-Silfiltret i duschen smutsigt -Backventil är defekt	-Rengör silfiltret mellan slangen och termostaten -Byt backventil
Blandare är trög	-Patron defekt, förkalkad	-Byt ut patron
Blandare droppar	-Patron defekt	-Byt ut patron
Varmvattentemperaturen är för låg	-Varmvattenreglering felaktigt inställd	-Ställ in varmvattenreglering
Varmvattenberedare slår ej på	-Vattenbegränsare i handduschen har ej tagits bort -Smutsfiltren är igensmutsade -Backventil är defekt	-Ta bort vattenbegränsaren -Rengör / byt smutsfilter -Byt backventil

Varmvattenreglering: Varmvattentemperatur 60 C, Kallvattentemperatur 10 C, flödestryck 0,3 MPa.

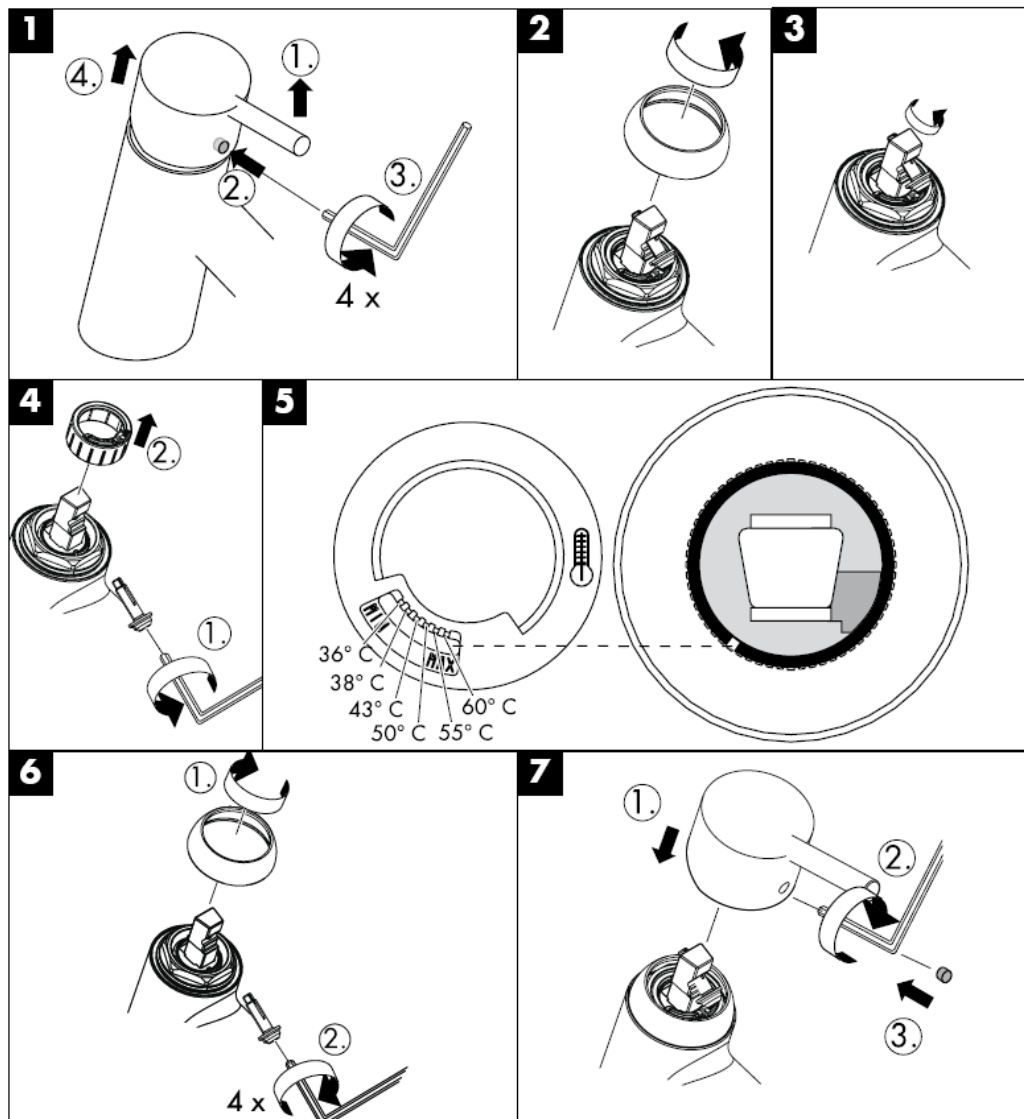

Rengöring

Med QuickClean, den manuella rengöringsfunktionen, är det lätt att befria strålkanelerna från kalk - de ska bar gnuggas.

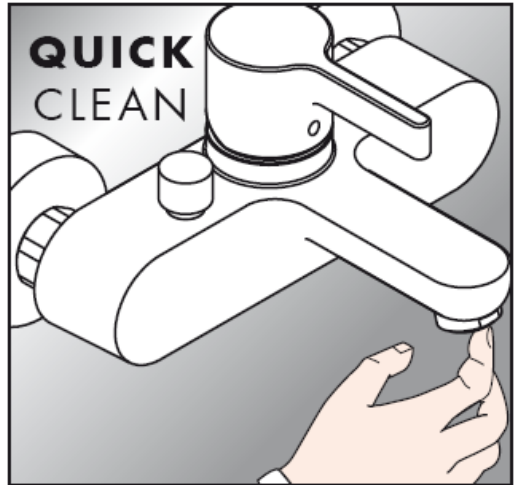

hansgrohe

Hansgrohe · Postfach 1145 · D-77761 Schiltach · Telefon +49 (0) 78 36/51-1282 · Telefax +49 (0) 7836/511440
E-Mail: info@hansgrohe.com · Internet: www.hansgrohe.com

11/2008
9.06851.01
Svenska

Montavimo instrukcijos

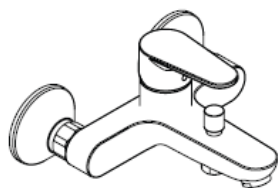

Talis E²
31642000

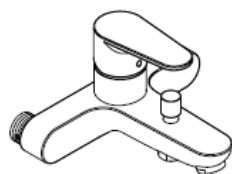

Talis E²
31643000



Talis E²
31662000



Talis E²
31667000

hansgrohe

31642000

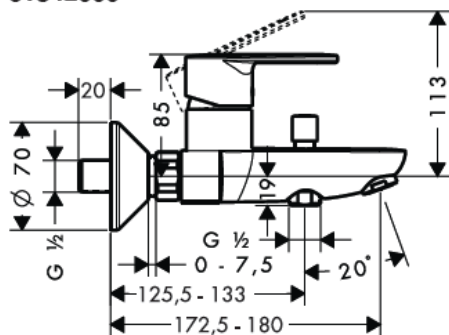

31662000

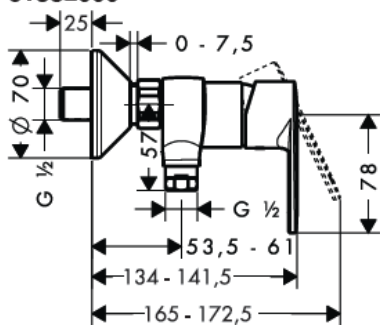

31643000

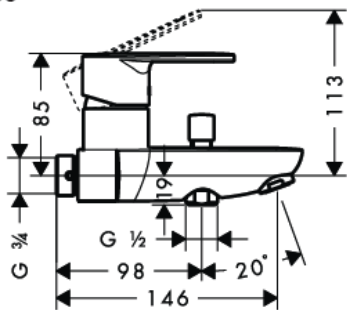

AD 153 mm

31667000

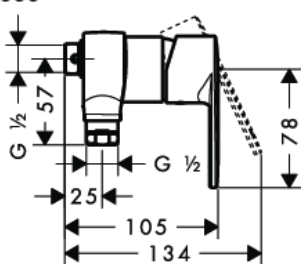

AD 153 mm

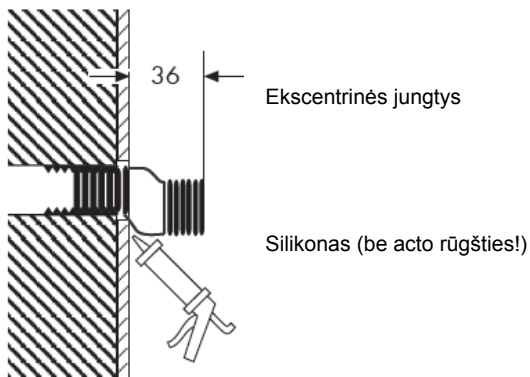



31642000

31662000 / 31667000

31642000 / 31643000

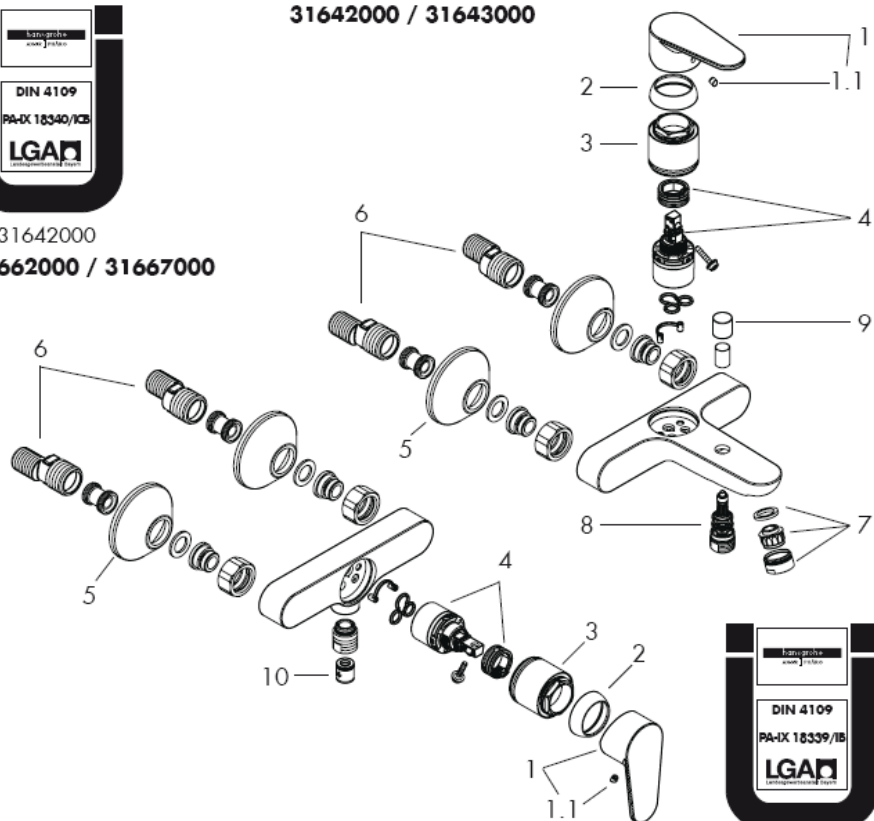

31662000

31643000 / 31667000

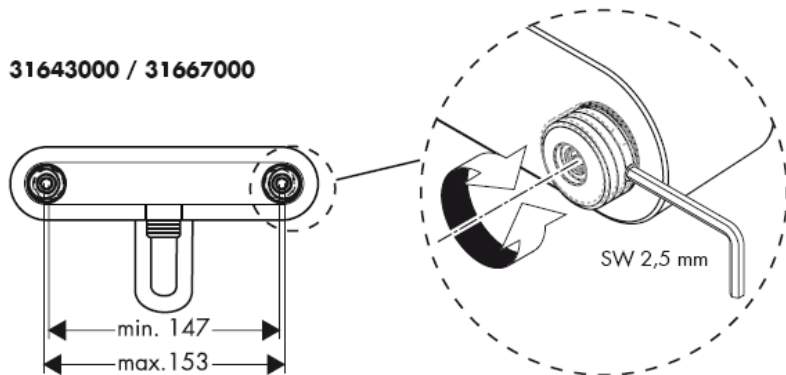

Dėmesio! Maišytuvas privalo būti montuojamas, išleidžiamas ir patikrinamas pagal galiojančias normas!

1. Išplauti vamzdžius.
2. Montuoti ekscentrines jungtis ir išlyginti.
3. Prisukite maišytuvą, naudodami sandariklius.

Turi būti išlyginti šalto ir karšto slėgio nelygumai.

Eksploatacija

Maišytuvas atidaromas pakėlus rankenėlę.

Pasukus rankenėlę į kairę, įjungiamas karštas vanduo; į dešinę - šaltas.

31642000 / 31643000 Dušo funkcija įjungjama patraukus rutulinį perjungiklį viršutinėje čiaupo dalyje. Uždarius vandenį, funkcija automatiškai grįžta į pradinę padėtį - vonios funkciją.

Techniniai duomenys

Darbinis slėgis:	max. 1 MPa
Rekomenduojamas slėgis:	0,1 – 0,5 MPa
Bandomasis slėgis:	1,6 MPa
(1 MPa = 10 bar = 147 PSI)	
Karšto vandens temperatūra:	max. 80° C
Rekomenduojama karšto vandens temperatūra:	65° C
Atstumas tarp centrų:	
Prijungimas G ½": Šaltas vanduo dešinėje, karštas - kairėje	
Vandens pralaidumas:	ca. 17 l/min 0,3 MPa
Su atbuliniu vožtuvu	

Vienos rankenėlės maišytuvas turi karšto vandens ribotuvą (nustatymą žr. psl. 6). Naudojant momentinį šildiklį karšto vandens ribotuvus nebūtinai.

"Hansgrohe" vienos rankenėlės maišytuvai gali būti naudojami su hidrauliškai ir termiškai reguliuojamais momentiniais šildikliais, kai vandens slėgis mažesnis kaip 0,15 MPa.

Dėmesio!

Atbulinių vožtuvėlių funkcija, remiantis DIN 1988, vieną kartą metuose privalo būti patikrinta.

Atsarginės dalys (žr. psl. 3)

1	Rankenėlė	31692000
1.1	Dangtis	96338000
2	dangtis	97406000
3	veržlė	97977000
4	kasetė	92730000
5	Dangtis	96135000
6	Ekscentrinės jungtys	94140000
7	oro kompresorius	96429000
8	Perjungiklis	13956000
9	Perjungiklio mygtukas	97978000
10	atbulinis vožtuvas	97980000

Lietuviškai

Bandyimo pažyma

	PA-IX	DVGW	SVGW	KIWA	ACS	NF
31642000	PA-IX 18340/ICB	X	X	X	X	
31643000			X			
31662000	PA-IX 18339/IB	X	X	X	X	
31667000			X			

Gedimas	Priežastis	Priemonė
Per maža srovė	-Dušo galvos filtras užsikimšęs -Abulinis vožtuvas neveikia	-Išvalyti dušo galvos filtrą -Pakeisti atbulinį vožtuvą
Sunkiai sukiojama rankenėlė	-Kasetė pažeista, užkalkėjusi	-Pakeisti kasetę
Maišytuvas praleidžia vandenį	-Kasetė pažeista	-Pakeisti kasetę
Per maža karšto vandens temperatūra	-Neteisingai nustatytas karšto vandens ribotuvus	-Nustatyti karšto vandens ribotuvą
Momentinis pašildytojas neįsijungia	-Neišimtas ribotuvus iš dušo galvutės -Užsikimšęs filtras -Abulinis vožtuvas neveikia	-Išimti ribotuvą iš dušo galvutės -Išvalyti / pakeisti filtrą -Pakeisti atbulinį vožtuvą

Karšto vandens ribotuvas: karšto vandens temperatūra 60 C, šalto vandens - 10 C, slėgis 0,3 MPa..

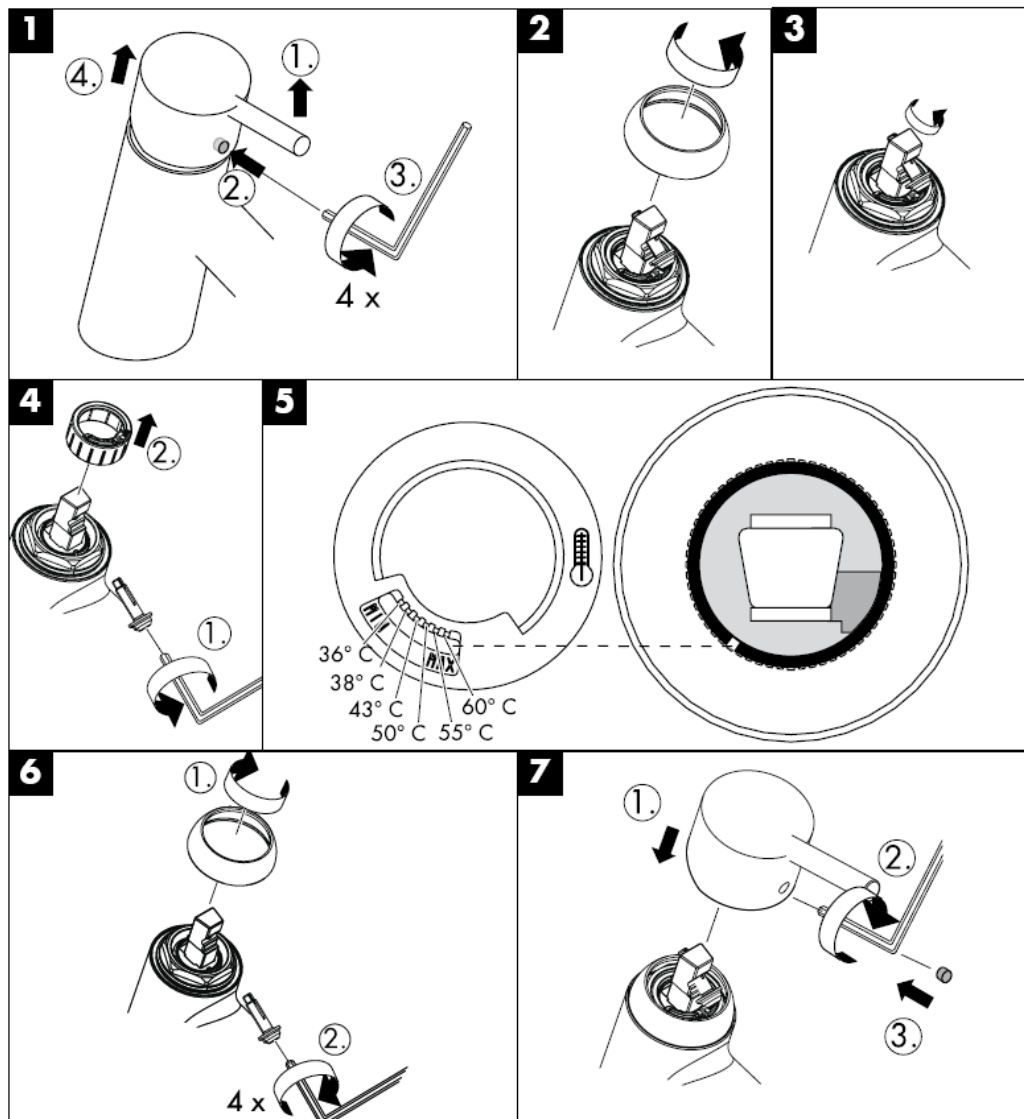

Valymas

"QuickClean" valymo funkcija apsaugo nuo apkalkėjimo. Užtenka pirštu nubraukti atsiradusius nešvarumus nuo srovės angų.

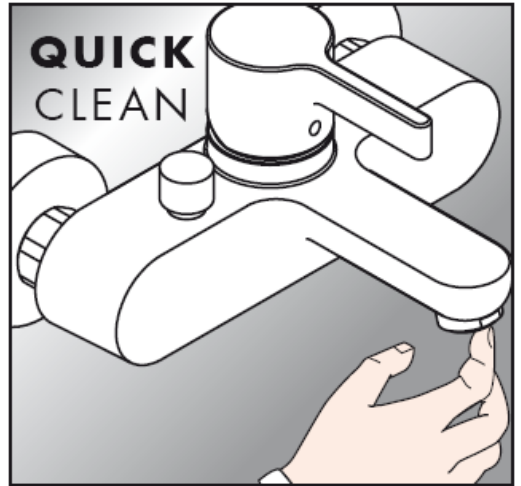

hansgrohe

Hansgrohe · Postfach 1145 · D-77761 Schiltach · Telefon +49 (0) 78 36/51-1282 · Telefax +49 (0) 7836/511440
E-Mail: info@hansgrohe.com · Internet: www.hansgrohe.com

11/2008
9.06851.01
Lietuviškai

Uputstva za instalaciju

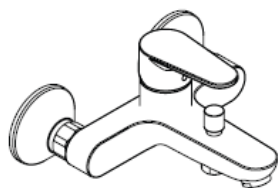

Talis E²
31642000

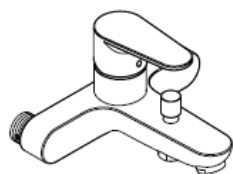

Talis E²
31643000



Talis E²
31662000



Talis E²
31667000

hansgrohe

31642000

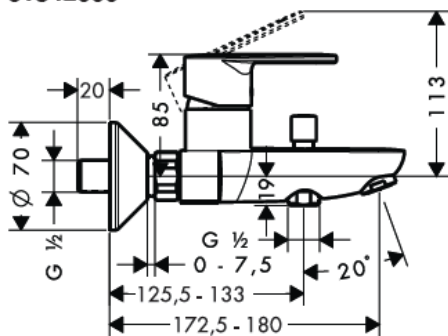

31662000

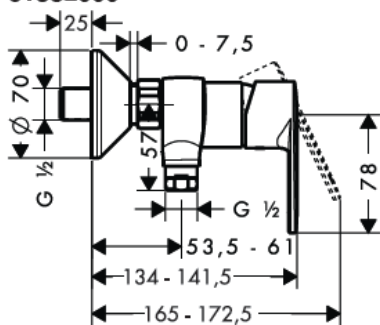

31643000

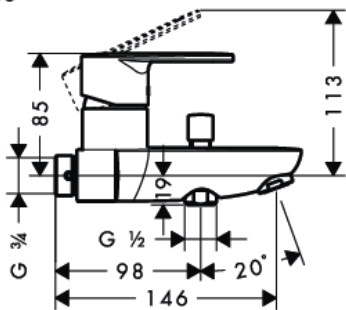

AD 153 mm

31667000

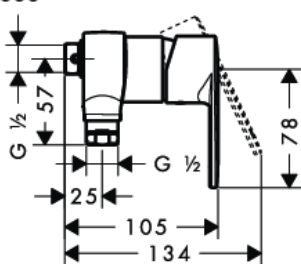

AD 153 mm

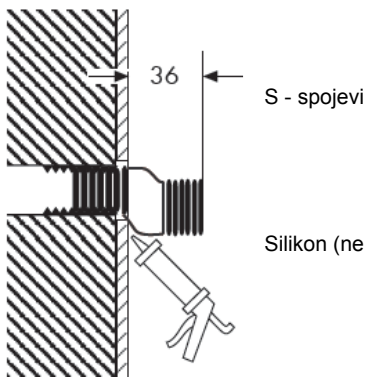

Silikon (ne sadrži kiseline)



31642000

31662000 / 31667000

31642000 / 31643000



31662000

31643000 / 31667000

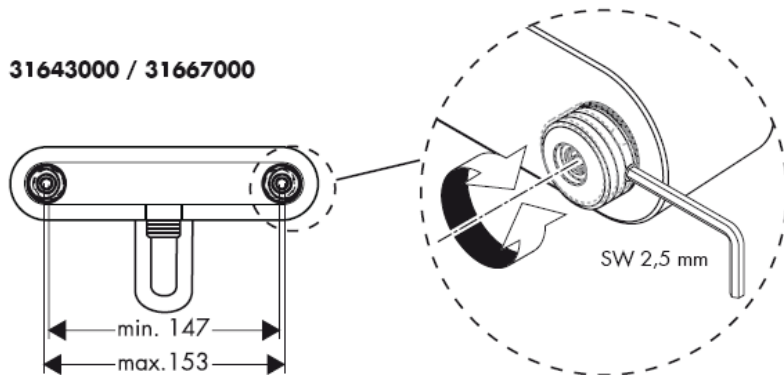

Pažnja! Cijevi moraju biti postavljene, isprane i testirane prema važećim normama!

1. Isperite cijevi dovoda.
2. Postavite S – spojeve i podesite ih.
3. Pritegnite vijke za pričvršćivanje.

Velika razlika u pritisku između vruće i hladne vode mora biti izbalansirana.

Upotreba

Slavina se otvara podizanjem ručice.

Okretanje ulijevo = vruća voda

Okretanje udesno = hladna voda

31642000 / 31643000 Prebacivanje na ručni tuš povlačenjem okrugle ručice na gornjoj strani slavine. Nakon zatvaranja slavine mješalica se automatski vraća u početnu poziciju.

Tehnički podatci

Najveći dopušteni tlak: max. 1 MPa

Preporučeni tlak: 0,1 – 0,5 MPa

Probni tlak: 1,6 MPa

(1 MPa = 10 bar = 147 PSI)

Temperatura vruće vode: max. 80° C

Preporučena temperatura vruće

vode: 65° C

Razmak od sredine:

Spojevi G ½": hladna desno – topla lijevo

Protok vode: ca. 17 l/min 0,3 MPa

Funkcije samo-čišćenja

Da bi podesili limiter vruće vode na jednoručnim slavinama molimo Vas da pogledate stranicu 6.

Podešavanje nije potrebno ako koristite protočni bojler.

Hansgrohe jednoručne slavine se mogu koristiti sa hidrauličnim i termički kontroliranim protočnim bojlerima ako je tlak najmanje 0,15 MPa.

Pažnja!

Nepovratni ventil se mora provjeravati jednom godišnje prema standardu DIN 1988

Rezervni djelovi (pogledaj stranicu 3)

1	Ručica	31692000
1.1	Poklopac vijka	96338000
2	Zaštita mehanizma	97406000
3	Matica	97977000
4	Uložak	92730000
5	Rozete	96135000
6	S - spojevi	94140000
7	Aerator pozlaćeni	96429000
8	selektor	13956000
9	Gumb usmjerivača	97978000
10	nepovratni ventil	97980000

Hrvatski

Oznaka testiranja

	PA-IX	DVGW	SVGW	KIWA	ACS	NF
31642000	PA-IX 18340/ICB	X	X	X	X	
31643000			X			
31662000	PA-IX 18339/IB	X	X	X	X	
31667000			X			

Greška	Uzrok	Otklanjanje
Nedovoljno vode	-Filter tuša je prljav -Nepovratni ventil se nije vratio u početni položaj	-Očistite filter između tuša i crijeva -Zamijenite nepovratni ventil
Ručica se zaglavila	-Neispravan uložak Taloženje kamenca	-Zamijenite uložak
Slavina kaplje	-Neispravan uložak	-Zamijenite uložak
Preniska temperatura tople vode	-Limiter vruće vode nije dobro podešen	-Podesite limiter vruće vode
Protočni bojler ne radi	-Limiter protoka u ručnom tušu nije odstranjen -Filtri su prljavi -Nepovratni ventil se nije vratio u početni položaj	-Odstranite limiter protoka -Očistite ili zamijenite filter -Zamijenite nepovratni ventil

Limitér vruće vode: temperatura vruće vode 60 C, temperatura hladne vode 10 C, tlak 0,3 MPa.

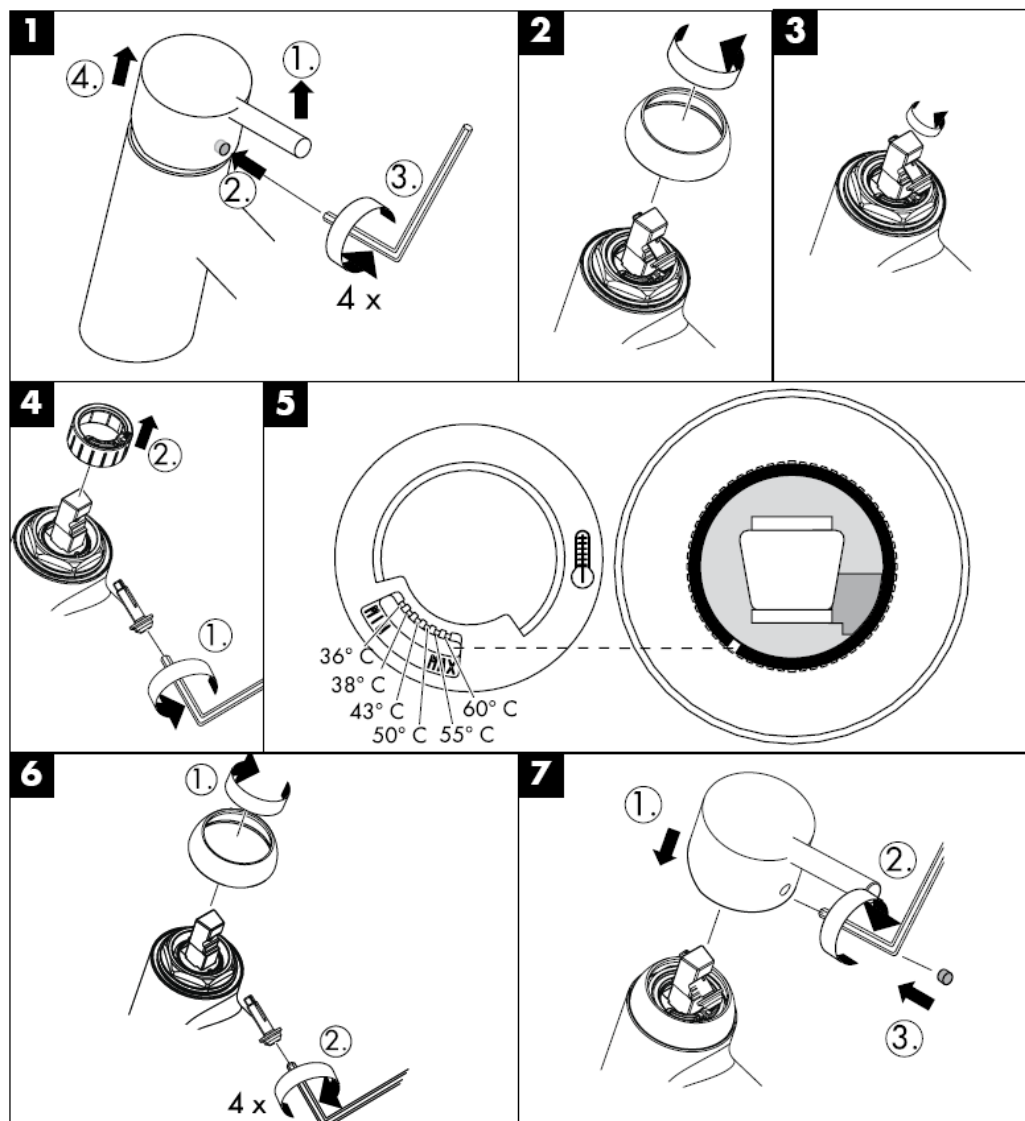

Čišćenje

QuickClean - ručni sustav za čišćenje omogućuje jednostavnim trljanjem odstranjivanje kamenca sa rupica prskalice tuša.



hansgrohe

Hansgrohe · Postfach 1145 · D-77761 Schiltach · Telefon +49 (0) 78 36/51-1282 · Telefax +49 (0) 7836/511440
E-Mail: info@hansgrohe.com · Internet: www.hansgrohe.com

11/2008
9.06851.01
Hrvatski

Montaj kılavuzu

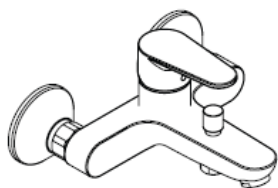

Talis E²
31642000

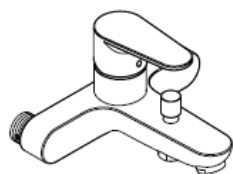

Talis E²
31643000



Talis E²
31662000



Talis E²
31667000

hansgrohe

31642000

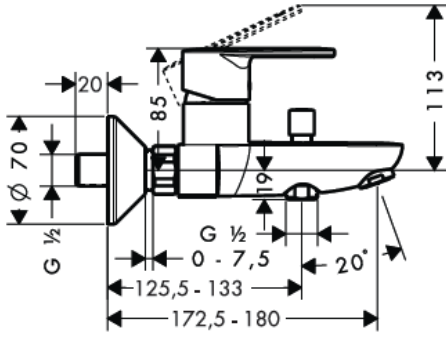

31662000

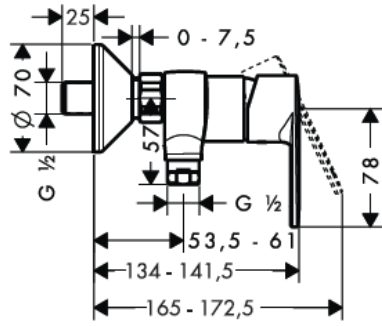

31643000

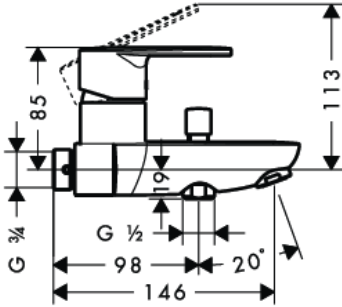

AD 153 mm

31667000

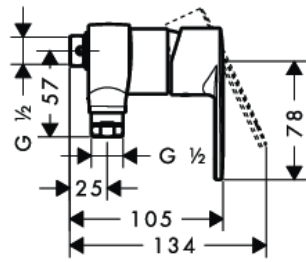

AD 153 mm

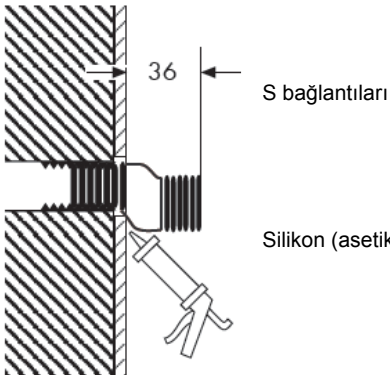

Silikon (asetik asit içermeyen)



31642000

31662000 / 31667000

31642000 / 31643000



31662000

31643000 / 31667000

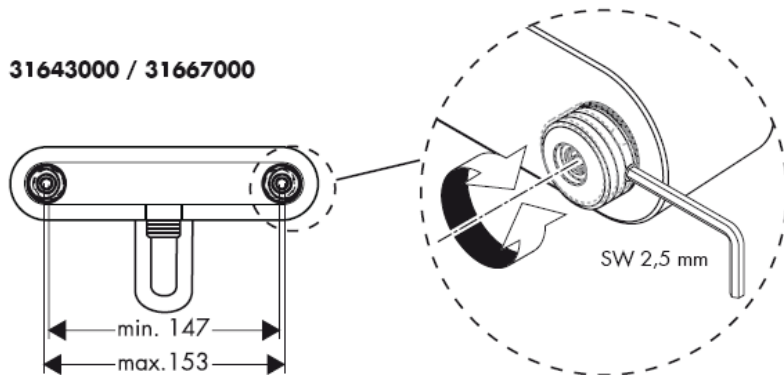

Önemli! Batarya geçerli normlara göre monte edilmeli, yıkanmalı ve kontrol edilmelidir!

1. Su giriş hatlarından su akıtarak boruları iyice temizleyiniz.
2. S Bağlantıları monte edip bataryanın düzlüğünü ayarlayınız.
3. Bataryayı contaları ile birlikte monte ediniz.

Sıcak ve soğuk su bağlantıları arasında büyük basınç farklılıkları varsa, bu basınç farklılıklarının dengelenmesi gerekir.

Kullanımı

Musluk kolunu yukarıya doğru kaldırınca miks batarya açılır.

Gövdede ki kolu sola çevrildiğinde = sıcak su,
Gövdede ki kolu sağa çevrildiğinde = soğuk su.
31642000 / 31643000 Çıkışın üst tarafındaki yuvarlak düğmeyi çekerek el duşunu değiştirin.
Geri ayar, kumanda kolu kapatılarak otomatik şekilde gerçekleşir.

Teknik bilgiler

İşletme basıncı: max. 1 MPa
Tavsiye edilen işletme basıncı: 0,1 – 0,5 MPa
Kontrol basıncı: 1,6 MPa
(1 MPa = 10 bar = 147 PSI)
Sıcak su sıcaklığı: max. 80° C
Tavsiye edilen su ısı: 65° C
Bağlantı ölçüleri:
G ½" bağlantılar: soğuk sağ - sıcak sol
Debisi : ca. 17 l/min 0,3 MPa
Geri emme önleyici

Sıcak su sınırlayıcı özelliğine sahip tek kollu bataryanın ayarlanması için 6. sayfaya bakınız.
Bir sürekli akışlı su ısıtıcısı ile birlikte kullanılırsa sıcak su sınırlayıcısına gerek kalmaz.

Su akış basıncı en azından 0,15 MPa olan yerlerde Hansgrohe tek kollu bataryalarını, hidrolik ve termik kumandalı şofbenlerle birlikte kullanabilirsiniz.

Önemli!

Çek valflara DIN 1988'e göre yılda bir kez çalışma kontrolü yapılmalıdır.

Yedek Parçalar (Bakınız sayfa 3)

1	Kumanda kolu	31692000
1.1	Vida tıpası	96338000
2	Ayna	97406000
3	Somun	97977000
4	Kartuş	92730000
5	Yedek parça	96135000
6	S bağlantıları	94140000
7	Perlatör	96429000
8	Divertör (komple)	13956000
9	Divertör kolu	97978000
10	Çek valf	97980000

Türkçe

Kontrol işareti

	PA-IX	DVGW	SVGW	KIWA	ACS	NF
31642000	PA-IX 18340/ICB	X	X	X	X	
31643000			X			
31662000	PA-IX 18339/IB	X	X	X	X	
31667000			X			

arıza	sebeup	yardımp
Az su geliyor	-Duşun süzgeci tıkanmış olabilir -Çek valf çalışmıyor olabilir	-El duşu ile hortum arasındaki hortumu yıkayın -Çek valfı değiştirin
Batarya kullanımı ağırlaşıyor	-Kartuş Bozulmuş ve kireçlenmiş olabilir	-Kartuşu değiştirin
Batarya su damlatıyor	-Kartuş bozuk olabilir	-Kartuşu değiştirin
Sıcak suyun derecesi çok düşük	-Isı limitleyici düzgün çalışmıyor	-Isı limitleyiciyi yeniden ayarlayın
Şofben çalışmıyor	-El duşunun içindeki akım limitleyici çıkartılmamış olabilir -Filtre tıkanmış olabilir -Çek valf çalışmıyor olabilir	-Akım limitleyiciyi el duşundan çıkartın -Filtreyi temizleyin yada çıkartın -Çek valfı değiştirin

Sıcak su sınırlaması: Sıcak su sıcaklığı 60 C, soğuk su sıcaklığı 10 C, akma basıncı 0,3 MPa.

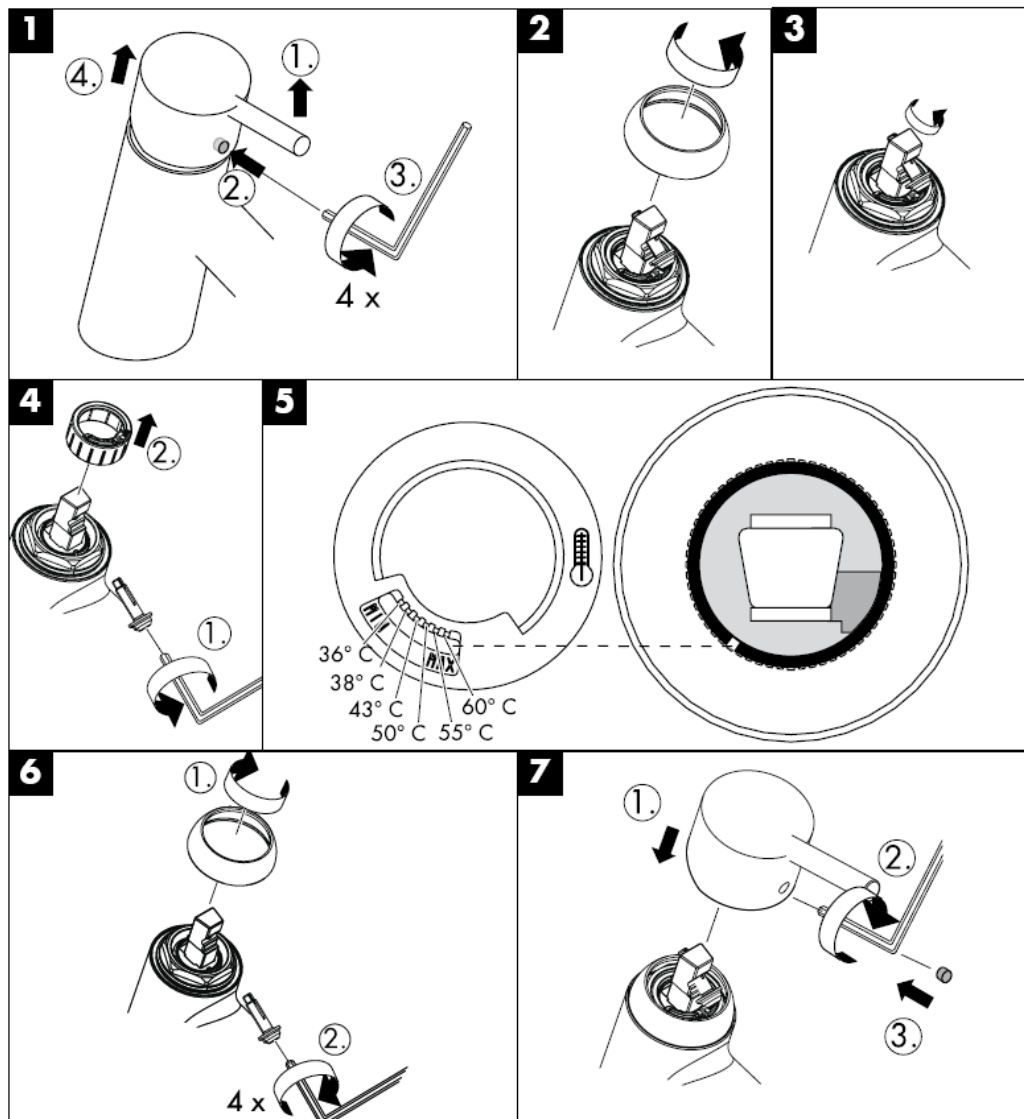

Temizleme

QuickClean, üründe bulunan bir temizleme fonksiyonudur. Basit bir ovuşturma ile spray modüllerdeki kireci çözer.

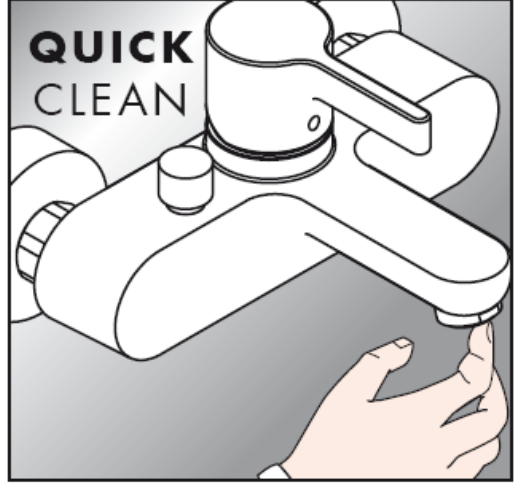

hansgrohe

Hansgrohe · Postfach 1145 · D-77761 Schiltach · Telefon +49 (0) 78 36/51-1282 · Telefax +49 (0) 7836/511440
E-Mail: info@hansgrohe.com · Internet: www.hansgrohe.com

11/2008
9.06851.01
Türkçe

Instrucțiuni de montare

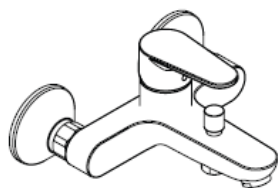

Talis E²
31642000

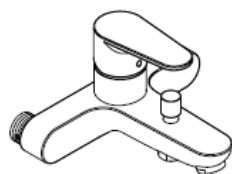

Talis E²
31643000



Talis E²
31662000



Talis E²
31667000

hansgrohe

31642000

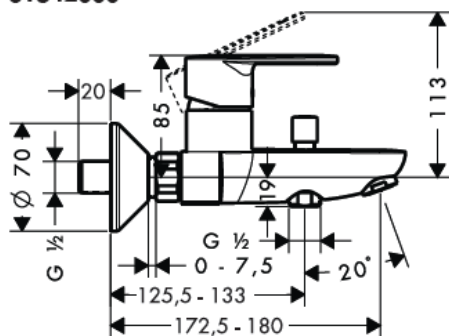

31662000

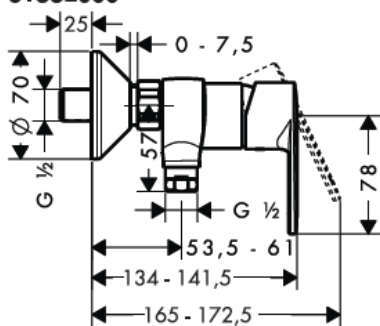

31643000

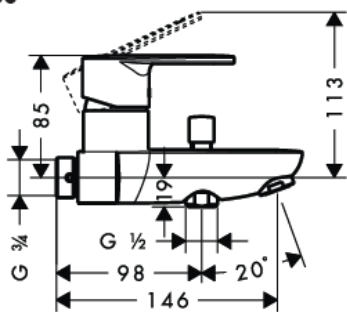

AD 153 mm

31667000

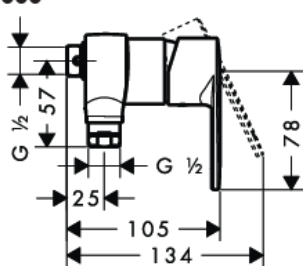

AD 153 mm

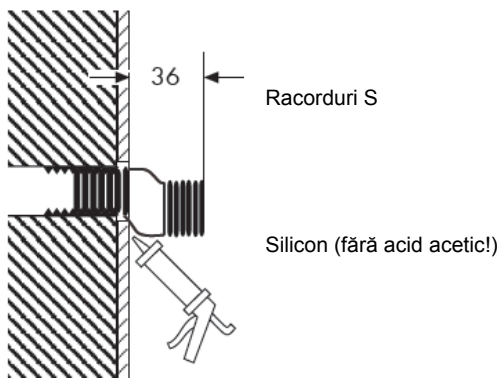



31642000

31662000 / 31667000

31642000 / 31643000



31662000

31643000 / 31667000

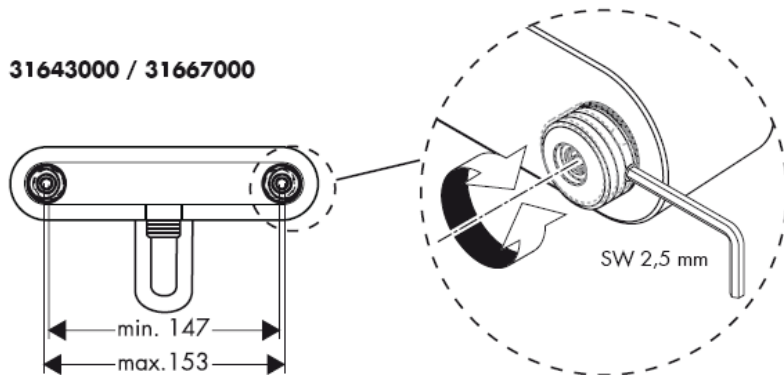

Atenție! Bateria trebuie montată, clătită și verificată conform normelor în vigoare.

1. Clătiți conductele de alimentare în mod profesional.
2. Montați și instalați racordurile S.
3. Fixați bateria cu garnituri.

Diferențele de presiune mari între alimentarea cu apă rece și apă caldă trebuie echilibrate.

Utilizare

Deschideți bateria prin ridicarea manetei.
Rotire spre stânga = apă caldă,
rotire spre dreapta = apă rece.
31642000 / 31643000 Selectați modul de funcționare duș manual prin tragerea butonului pe partea superioară a pipei. Se revine la jetul normal după închiderea apei la baterie.

Date tehnice

Presiune de funcționare: max. 1 MPa
Presiune de funcționare recomandată: 0,1 – 0,5 MPa
Presiune de verificare: 1,6 MPa
(1 MPa = 10 bar = 147 PSI)
Temperatura apei calde: max. 80° C
Temperatura recomandată a apei calde: 65° C
Interax racorduri:
Racorduri G ½ : rece - dreapta / cald - stânga
Debit de apă: ca. 17 l/min 0,3 MPa
Asigurat contra scurgere înapoi

Bateria monocomadă cu limitarea apei calde, pentru reglare vezi pag. 6.

Dacă conectați bateria la un boiler instant nu este necesară instalarea unui opritor de apă caldă.

Bateriile monocomadă Hansgrohe pot fi utilizate cu boiler instant cu comandă termică sau hidraulică dacă presiunea apei de alimentare este de min. 0,15 MPa.

Atenție!

Supapele antiretur trebuie verificate anual conform DIN 1988.

Piese de schimb (vezi pag. 3)

1	Mâner	31692000
1.1	Dop filetat	96338000
2	capac	97406000
3	Piuliță	97977000
4	Cartuș cpl.	92730000
5	Șild	96135000
6	Racorduri S	94140000
7	Pulverizator aer cpl.	96429000
8	Comutator cpl.	13956000
9	Buton de tragere	97978000
10	Supapă de reținer	97980000

Română

Certificat de testare

	PA-IX	DVGW	SVGW	KIWA	ACS	NF
31642000	PA-IX 18340/ICB	X	X	X	X	
31643000			X			
31662000	PA-IX 18339/IB	X	X	X	X	
31667000			X			

Deranjament	Cauza	Măsuri de remediere
Prea puțină apă	-S-a murdărit garnitura de sită a capătului de duș. -S-a blocat supapa antiretur.	-Curățați garnitura sită dintre capătul duș și furtun. -Schimbați supapa antiretur.
Bateria se mișcă dificil	-Cartuș defect din cauza depunerilor de calcar	-Schimbați cartușul.
Bateria picură	-Cartuș defect	-Schimbați cartușul.
Temperatura apei calde este prea mică	-Limitarea temperaturii apei calde setată incorect.	-Setați limitarea temperaturii apei calde.
Boilerul instant nu funcționează.	-Reductorul nu a fost demontat din dușul de mână. -Sitele de impurități murdare. -S-a blocat supapa antiretur.	-Îndepărtați reductorul din dușul de mână. -Curățați / schimbați sitele de impurități. -Schimbați supapa antiretur.

Limitator pentru apă caldă: Temperatură apă caldă: 60 C, temperatură apă rece: 10 C, presiune de curgere: 0,3 MPa.

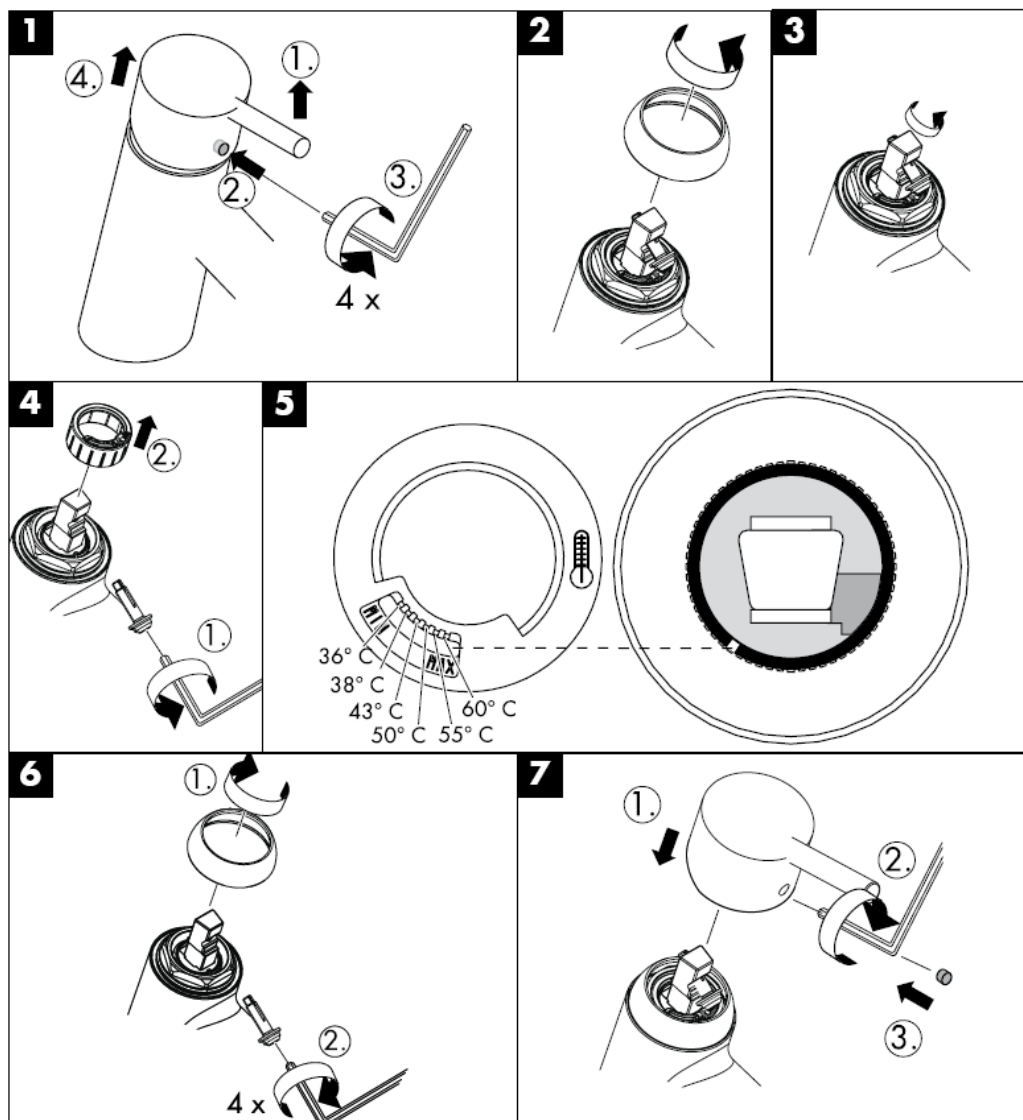

Curățare

Cu ajutorul sistemului QuickClean puteți să îndepărtați depunerile de calcar de pe diferitele duze de jet de apă prin frecare.

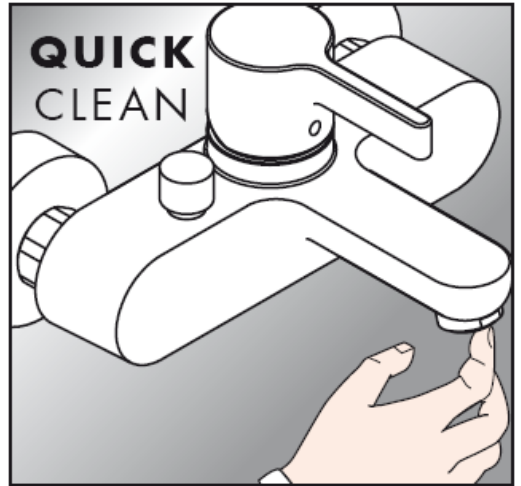

hansgrohe

Hansgrohe · Postfach 1145 · D-77761 Schiltach · Telefon +49 (0) 78 36/51-1282 · Telefax +49 (0) 7836/511440
E-Mail: info@hansgrohe.com · Internet: www.hansgrohe.com

11/2008
9.06851.01
România

Οδηγία συναρμολόγησης

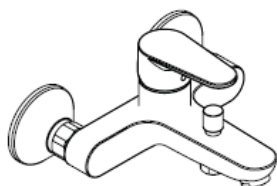

Talis E²
31642000

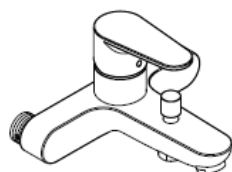

Talis E²
31643000



Talis E²
31662000



Talis E²
31667000

hansgrohe

31642000

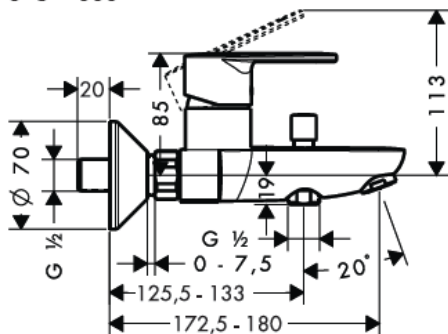

31662000

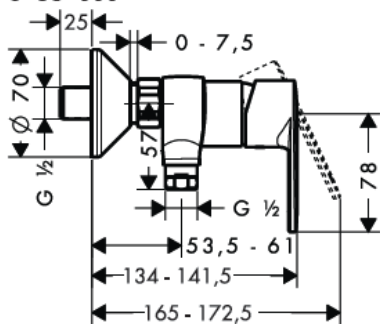

31643000

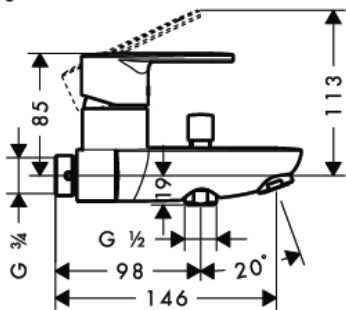

AD 153 mm

31667000

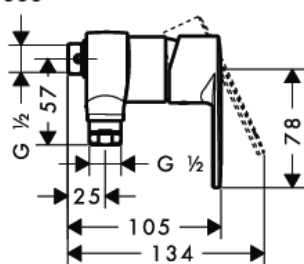

AD 153 mm

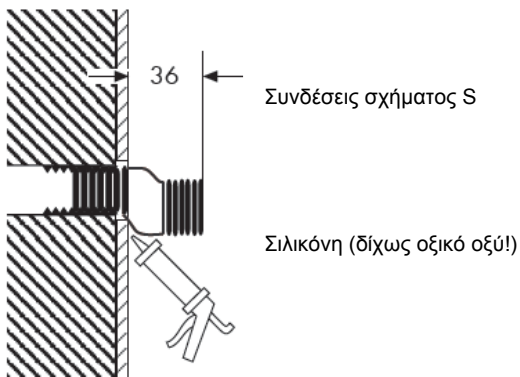



31642000

31662000 / 31667000

31642000 / 31643000

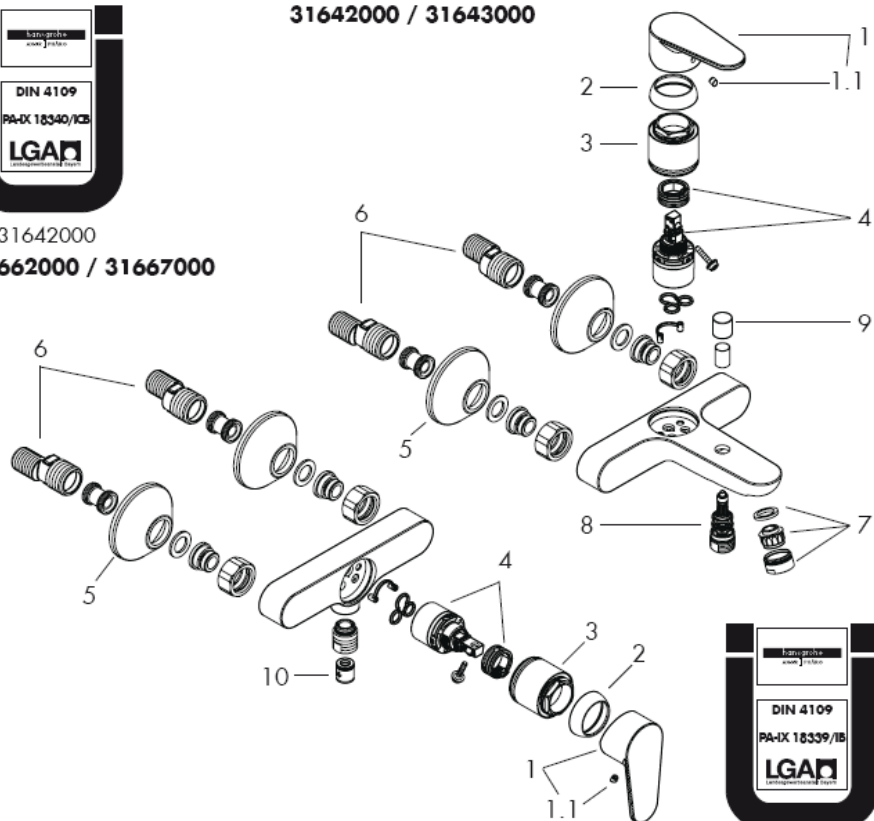

31662000

31643000 / 31667000

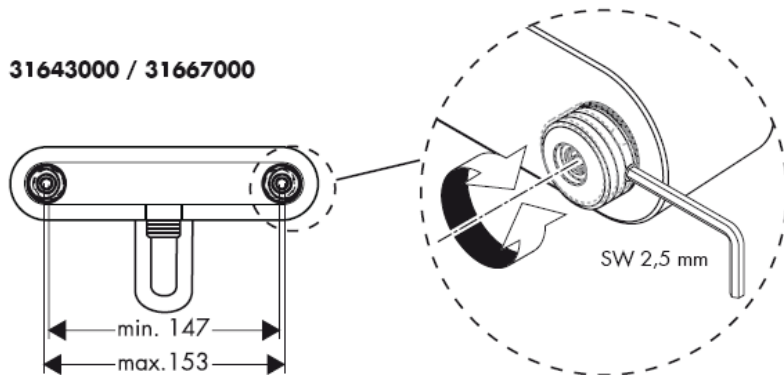

Προσοχή! Η κεντρική βάνα πρέπει να τοποθετηθεί, να πλυθεί και να ελεγχθεί με βάση τους ισχύοντες κανόνες υδραυλικής τέχνης!

1. Πλένετε καλά τις σωληνώσεις σύνδεσης.
2. Συναρμολογήστε τις συνδέσεις σχήματος S και οριζοντιώστε τις.
3. Βιδώστε σφικτά τη βάνα με τα παρεμβύσματα.

Οι διαφορές της πίεσης μεταξύ της σύνδεσης κρύου και ζεστού νερού θα πρέπει να αντισταθμίζονται.

Χειρισμός

Η μπαταρία λειτουργεί σηκώνοντας την κεντρική λαβή.

Γυρνώντας στα αριστερά = ζεστό νερό,

Γυρνώντας στα δεξιά = κρύο νερό.

31642000 / 31643000 Μεταβείτε σε καταιονιστήρα χειρός τραβώντας το στρογγυλό κουμπί στην άνω πλευρά του ρουξουνιού. Η επαναφορά της δέσμης πραγματοποιείται αυτόματα με το κλείσιμο της λαβής.

Τεχνικά Χαρακτηριστικά

Λειτουργία πίεσης: max. 1 MPa

Συνιστώμενη λειτουργία πίεσης: 0,1 – 0,5 MPa

Πίεση ελέγχου: 1,6 MPa

(1 MPa = 10 bar = 147 PSI)

Θερμοκρασία ζεστού νερού: max. 80° C

Συνιστώμενη θερμοκρασία ζεστού νερού: 65° C

Διαστάσεις σύνδεσης:

Συνδέσεις G ½: κρύο δεξιά – ζεστό αριστερά

Κατανάλωση νερού: ca. 17 l/min 0,3 MPa

Περιλαμβάνει βαλβίδα αντεπιστροφής.

Για να προσαρμόσετε το δοσομετρητή ζεστού νερού σε αναμεικτικές μπαταρίες, παρακαλούμε δείτε τη ρύθμιση στη σελ. 6.

Δεν είναι απαραίτητη η διάταξη φραγής ζεστού νερού σε συνδυασμό με ταχυθερμοσίφωνα.

Οι αναμεικτικές μπαταρίες Hansgrohe μπορούν να λειτουργούν και σε συνδυασμό με ταχυθερμοσίφωνα θερμικού ή υδραυλικού ελέγχου, εφόσον η ελάχιστη πίεση ροής είναι 0,15 MPa.

Προσοχή!

Οι βαλβίδες αντεπιστροφής πρέπει να ελέγχονται μια φορά το χρόνο ως προς τη λειτουργία τους, σύμφωνα με το πρότυπο DIN 1988.

Ανταλλακτικά (βλ. σελίδα 3)

1	Λαβή	31692000
1.1	πώμα λαβής	96338000
2	Καλύπτρα	97406000
3	Παξιμάδι	97977000
4	Φυσίγγιο, πλήρες	92730000
5	Ροζέττα	96135000
6	Συνδέσεις σχήματος S	94140000
7	Φίλτρο, πλήρες	96429000
8	Επιλογέας, πλήρης	13956000
9	Κουμπί εναλλάκτη	97978000
10	Βαλβίδα αντεπιστροφής	97980000

Ελληνικά

Σήμα ελέγχου

	PA-IX	DVGW	SVGW	KIWA	ACS	NF
31642000	PA-IX 18340/ICB	X	X	X	X	
31643000			X			
31662000	PA-IX 18339/IB	X	X	X	X	
31667000			X			

Βλάβη	Αιτία	Διόρθωση
Ανεπαρκές νερό	-Βρώμικη στεγανοποιητική σήτα του καταιονιστήρα -Η βαλβίδα αντεπιστροφής δεν γυρίζει πίσω.	-Καθαρίστε και, εάν χρειαστεί, αλλάξτε τη στεγανοποιητική σήτα μεταξύ καταιονιστήρα και σπιράλ -Αλλάξτε τη βαλβίδα αντεπιστροφής
Σκληρή μπαταρία (μείκτης)	-Ελαττωματικό φυσίγγιο, άλατα	-Αλλαγή φυσιγγίου
Η μπαταρία στάζει	-Ελαττωματικό φυσίγγιο	-Αλλαγή φυσιγγίου
Χαμηλή θερμοκρασία ζεστού νερού	-Λάθος ρύθμιση της περιοριστικής διάταξης ζεστού νερού	-Ρυθμίστε την περιοριστική διάταξη του ζεστού νερού
Ο ταχυθερμοσίφωνας δεν ενεργοποιείται	-Το στραγγαλιστικό πηνίο δεν έχει αποσυναρμολογηθεί από τον καταιονιστήρα χειρός -Τα φίλτρο συλλογής ακαθαρσιών είναι λερωμένο -Η βαλβίδα αντεπιστροφής δεν γυρίζει πίσω.	-Καθαρίστε το στραγγαλιστικό πηνίο από τον καταιονιστήρα χειρός -Καθαρίστε/αλλάξτε το φίλτρο συλλογής ακαθαρσιών -Αλλάξτε τη βαλβίδα αντεπιστροφής

Διάταξη περιορισμού ζεστού νερού: θερμοκρασία ζεστού νερού 60 C, θερμοκρασία κρύου νερού 10 C, πίεση ροής 0,3 MPa.

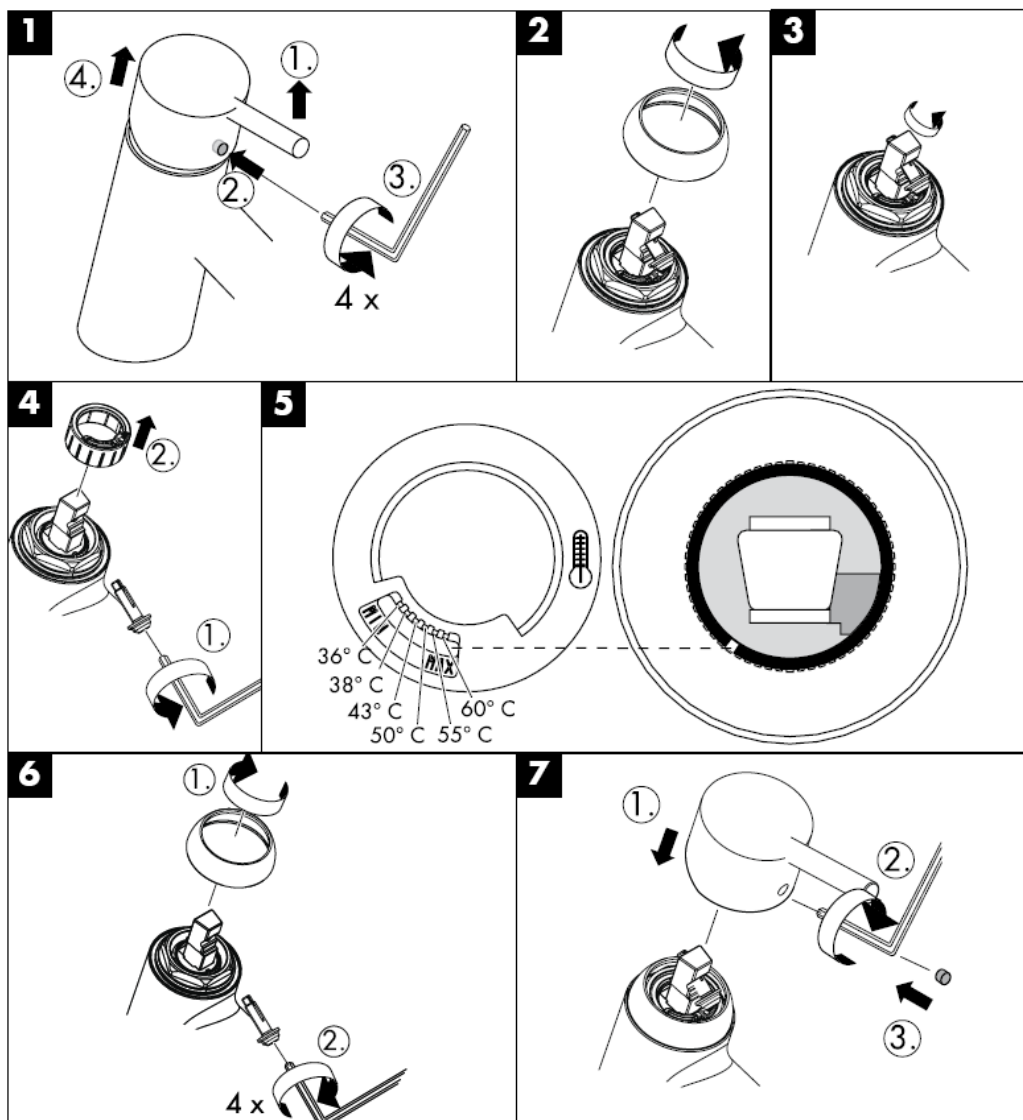

Καθαρισμός

Με QuickClean, τη λειτουργία καθαρισμού με το χέρι, μπορούν να απομακρυνθούν με απλό τρίψιμο τα άλατα από τα κανάλια του καταιονιστήρα.

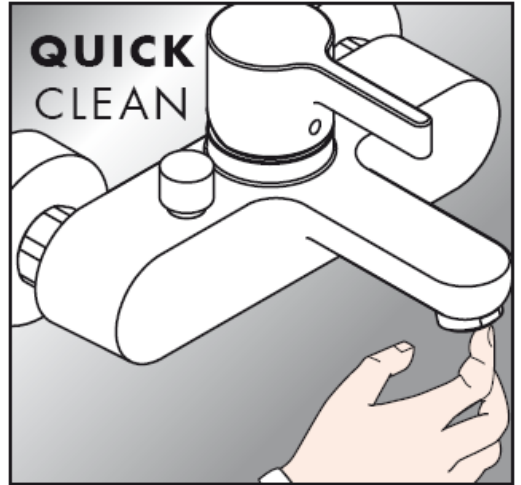

hansgrohe

Hansgrohe · Postfach 1145 · D-77761 Schiltach · Telefon +49 (0) 78 36/51-1282 · Telefax +49 (0) 7836/511440
E-Mail: info@hansgrohe.com · Internet: www.hansgrohe.com

11/2008
9.06851.01
Ελληνικά

تعليمات التجميع

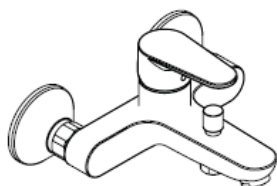

Talis E²
31642000

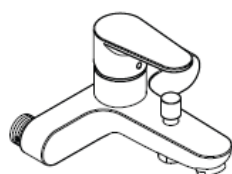

Talis E²
31643000



Talis E²
31662000



Talis E²
31667000

hansgrohe

31642000

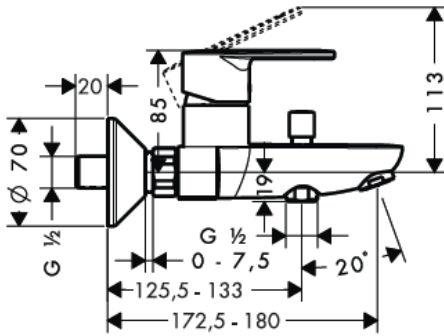

31662000

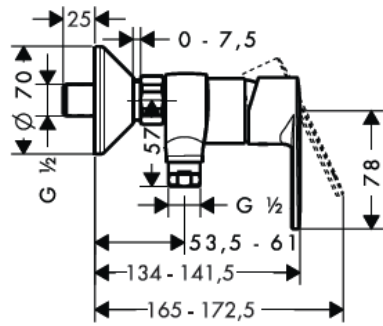

31643000

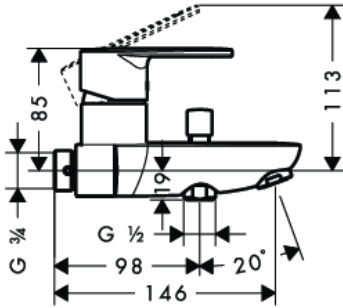

AD 153 mm

31667000

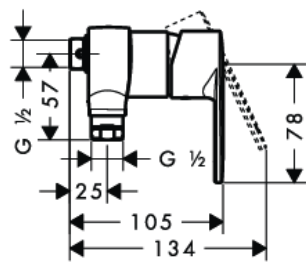

AD 153 mm

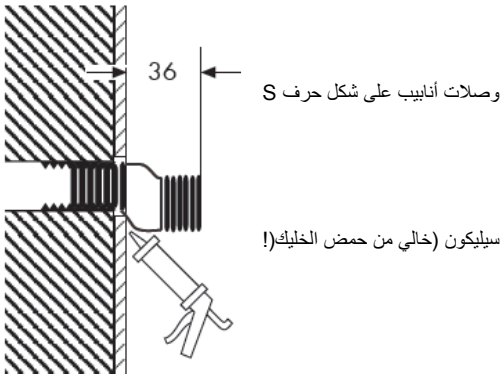



31642000

31662000 / 31667000

31642000 / 31643000



31662000

31643000 / 31667000

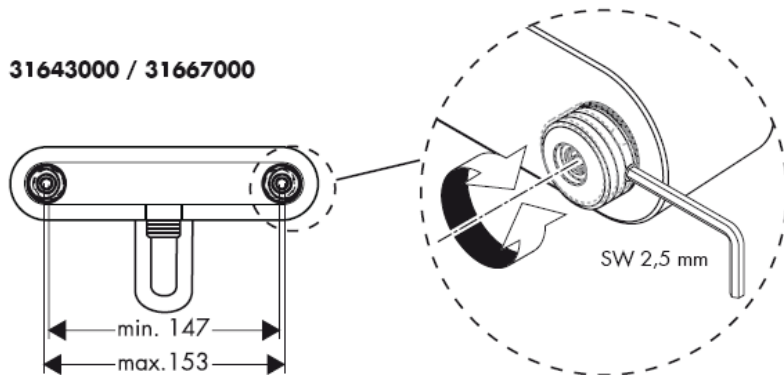

لضبط محدد الماء الساخن في الخلاطات ذات الرافعة الأحادية، يرجى الرجوع إلى صفحة 6. ولا يلزم إجراء أي ضبط عند استخدام سخان مياه ذي تدفق مستمر.

يمكن استخدام خلاطات هانزجرهه أحادية المقيض مع سخانات تدفق الماء ذات التحكم الهيدروليكي أو الحراري، مع ضغط تدفق لا يقل عن 1.5 بار.

تنبيه !

يجب فحص صمامات عدم الرجوع مرة واحدة سنوياً.

قطع الغيار (راجع صفحة 3)

31692000	1	مقيض
96338000	1.1	غطاء ملولب
97406000	2	فلانشة (شفة)
97977000	3	صمولة
92730000	4	خرطوشة
96135000	5	طرف
94140000	6	وصلات أنابيب على شكل حرف S
96429000	7	تجهيزة تهوية
13956000	8	مفتاح الاختيار
97978000	9	مقيض المحول
97980000	10	صمام عدم الرجوع

تنبيه! يجب تركيب الوصلة، وغمرها بالماء واختبارها وفقاً للمعايير السارية!

1. قم بدفع المياه خلال مواسير الإمداد.
2. قم بتركيب وصلات الأنابيب على شكل حرف S وقم بضبطها.
3. اربط الخلاط بالحلقات.

يجب أن يكون تيار الماء الساخن والماء البارد متعادلين في الضغط.

التشغيل

يتم تنشيط الخلاط من خلال رفع مقيض الرافعة.

التدوير إلى اليسار = ماء أكثر سخونة،

والتدوير إلى اليمين = ماء أكثر برودة.

31642000 / 31643000 يتحول تدفق المياه من الحوض إلى

النش من خلال سحب المقيض الدوار الموجود أعلى الصنبور. بعد

إغلاق تدفق المياه، يعود الخلاط تلقائياً إلى وظيفة الحوض.

المواصفات الفنية

max. 1 MPa

0,1 – 0,5 MPa

1,6 MPa

(1 MPa = 10 bar = 147 PSI)

max. 80° C

65° C

درجة حرارة الماء الساخن:

درجة الحرارة الموصى بها للماء الساخن:

المسافة المركزية:

الوصلات G ½: الماء البارد جهة اليمين - الماء الساخن جهة اليسار

ca. 17 l/min 0,3 MPa

معدل التدفق:

التأمين ضد التدفق العكسي

	PA-IX	DVGW	SVGW	KIWA	ACS	NF
31642000	PA-IX 18340/ICB	X	X	X	X	
31643000			X			
31662000	PA-IX 18339/IB	X	X	X	X	
31667000			X			

العطل	السبب	العلاج والإصلاح
الماء قليل	-سدادة مصفاة الدش متسخة	-نظف سدادة المصفاة بين الدش والخرطوم
الخلط ثقيل الحركة	-صمام منع الرجوع ثابت ولا يتحرك	-قم بتغيير صمام منع الرجوع
تساقط قطرات مياه من الخلط	-الخرطوشة تالفة، تراكم عليها الجير	-قم بتغيير الخرطوشة
درجة حرارة الماء الساخن منخفضة للغاية	-الخرطوشة تالفة	-قم بتغيير الخرطوشة
السخان الفوري لا يعمل	-حد الماء الساخن مضبوط بشكل خاطيء	-اضبط حد الماء الساخن
	-صمام العلق غير مخلوع من الدش	-اخلع صمام العلق من الدش
	-مرشحات الانتساخات متسخة	-قم بتنظيف / تغيير مرشحات الانتساخات
	-صمام منع الرجوع ثابت ولا يتحرك	-قم بتغيير صمام منع الرجوع

محدد الماء الساخن: درجة حرارة الماء الساخن 60 مئوية، درجة حرارة الماء البارد تبلغ 10 مئوية، ضغط التدفق 3 بار.

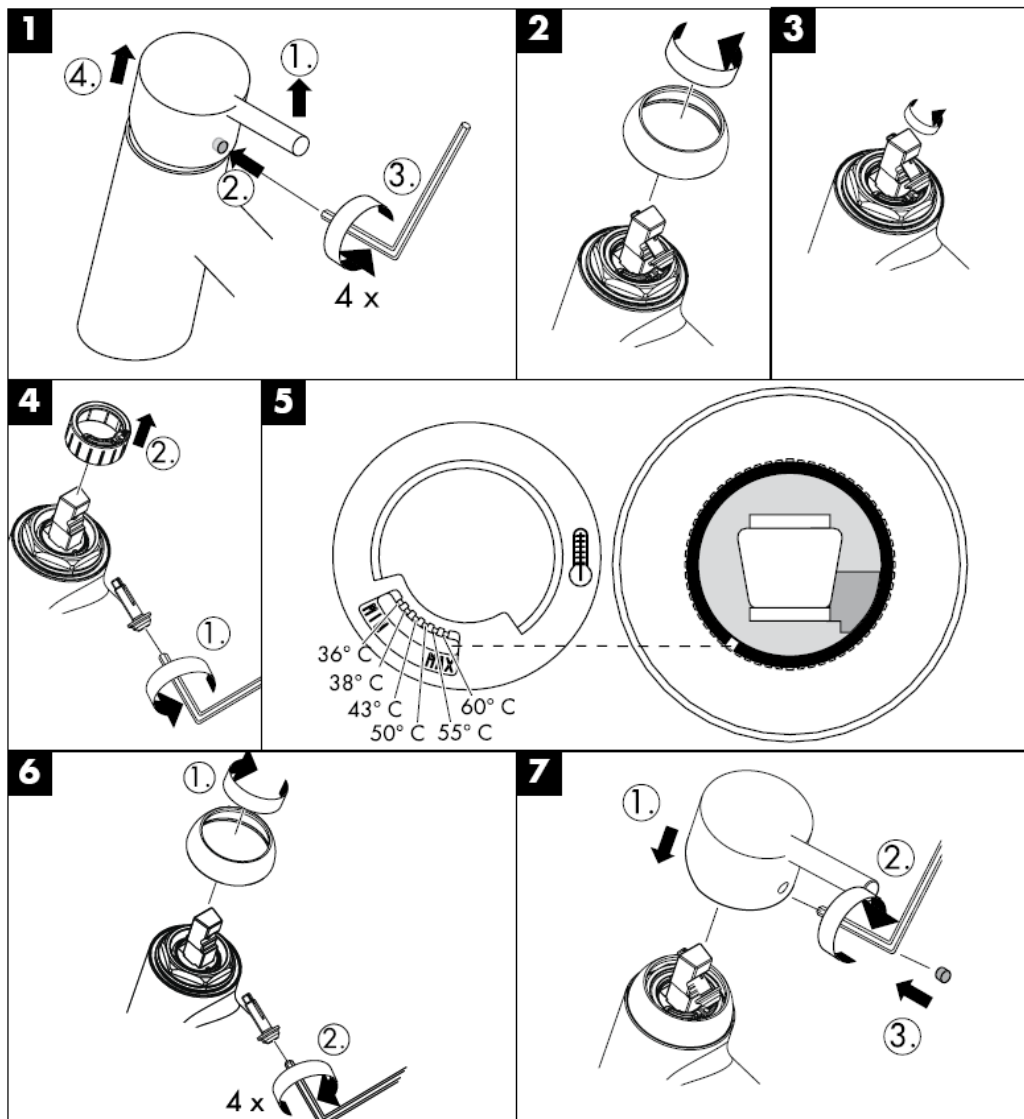

التنظيف

وباستخدام برنامج التنظيف "QuickClean" الذي يتميز بخاصية التنظيف الآلي، يمكن تنظيف وحدات دفع المياه من الجير عن طريق حكها برفق.

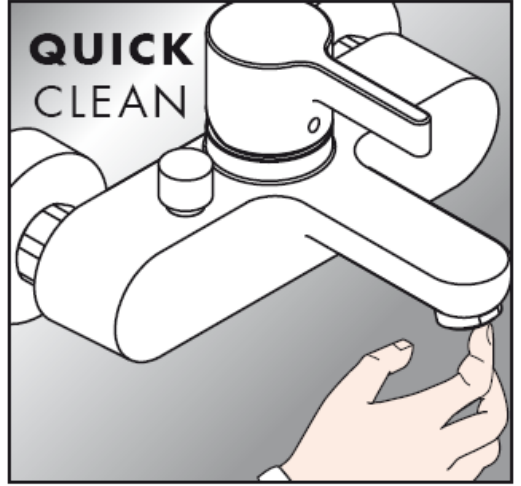

hansgrohe

Hansgrohe · Postfach 1145 · D-77761 Schiltach · Telefon +49 (0) 78 36/51-1282 · Telefax +49 (0) 7836/511440
E-Mail: info@hansgrohe.com · Internet: www.hansgrohe.com

11/2008
9.06851.01

عربي

Navodila za montažo

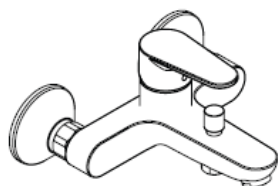

Talis E²
31642000

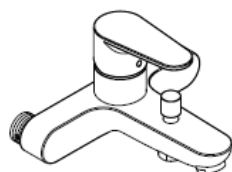

Talis E²
31643000



Talis E²
31662000



Talis E²
31667000

hansgrohe

31642000

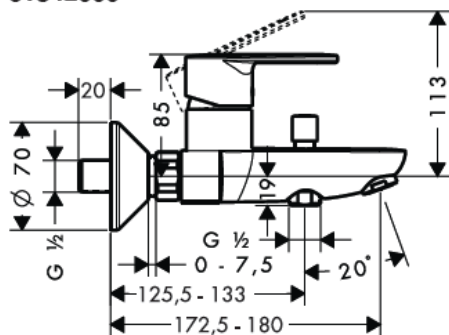

31662000

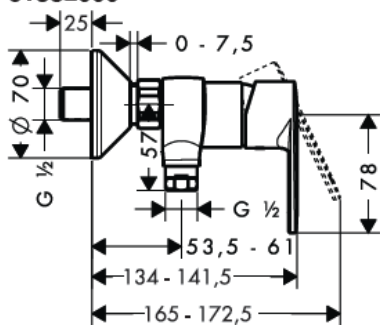

31643000

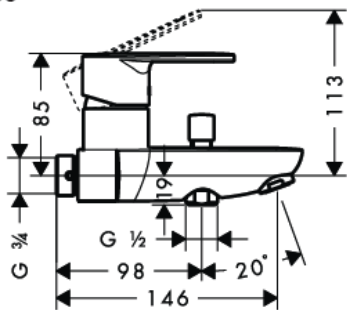

AD 153 mm

31667000

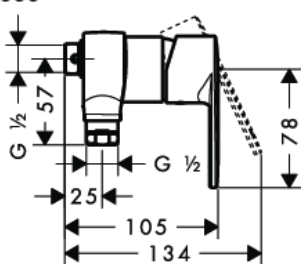

AD 153 mm

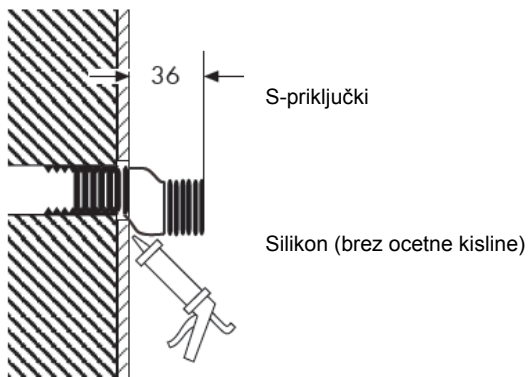



31642000

31662000 / 31667000

31642000 / 31643000



31662000

31643000 / 31667000

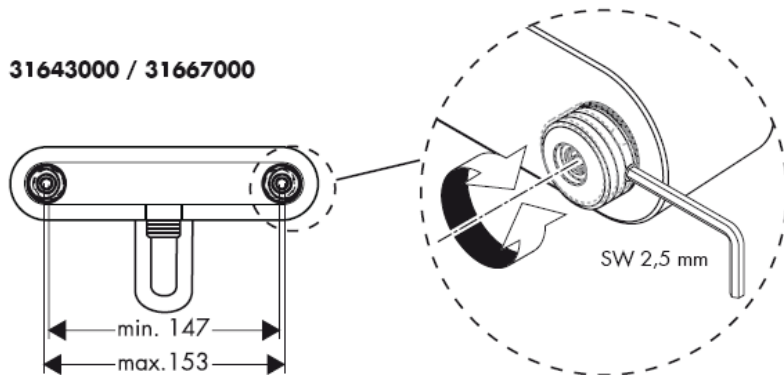

Pozor! Armaturo je potrebno montirati, sprati in testirati v skladu z veljavnimi normami!

1. Strokovno izplaknite dovodne cevi.
2. Monter les raccords.
3. Trdno privijte armaturo s tesnili.

Velike razlike v tlaku med priključkom za mrzlo in priključkom za toplo vodo je potrebno izravnati.

Upravljanje

Z dvigom ročke mešalno baterijo odprete. Zasuk v levo = topla voda, zasuk v desno = mrzla voda. 31642000 / 31643000 Na ročno prho preklopite tako, da povlečete za okrogli gumb na zgornji strani izliva. Po zaprtju ročke se avtomatsko vzpostavi prejšnje stanje.

Tehnični podatki

Delovni tlak:	max. 1 MPa
Priporočeni delovni tlak:	0,1 – 0,5 MPa
Preskusni tlak:	1,6 MPa
(1 MPa = 10 bar = 147 PSI)	
Temperatura tople vode:	max. 80° C
Priporočena temperatura tople vode:	65° C
Razdalja od sredine:	
Priključki G ½":	mrzla desno - topla levo
Pretok vode:	ca. 17 l/min 0,3 MPa
Zaščita proti povratnemu toku	

Enoročne mešalne baterije z omejevalnikom tople vode, za justiranje glejte stran 6.

V povezavi s pretočnimi grelniki zapora tople vode ni potrebna.

Enoročne mešalne baterije Hansgrohe lahko uporabljate v povezavi s hidravlično in termično uravnavanimi pretočnimi grelniki, če je pretočni tlak najmanj 0,15 MPa.

Pozor!

Delovanje protipovratnega ventila je potrebno v skladu z DIN 1988 enkrat letno testirati.

Rezervni deli (glejte stran 3)

1	Ročka	31692000
1.1	Pokrov/čep	96338000
2	Prirobnica	97406000
3	Matica	97977000
4	Vložek	92730000
5	Rozeta	96135000
6	S-priključki	94140000
7	Perlator kpl.	96429000
8	Preklopna ročica kpl.	13956000
9	Potezalka	97978000
10	Protipovratni ventil	97980000

Slovenski

Preskusni znak

	PA-IX	DVGW	SVGW	KIWA	ACS	NF
31642000	PA-IX 18340/ICB	X	X	X	X	
31643000			X			
31662000	PA-IX 18339/IB	X	X	X	X	
31667000			X			

Napaka	Vzrok	Pomoč
Malo vode	-Filtrirna mrežica prhe je umazana -Protipovratni ventil je obtičal	-Očistite filtrirno mrežico med prho in gibko cevjo -Zamenjajte protipovratni ventil
Težko premikanje armature iz armature kaplja	-Pokvarjen vložek, poapneno -Pokvarjen vložek	-Zamenjajte vložek -Zamenjajte vložek
Prenizka temperatura tople vode	-Omejevalnik tople vode ni pravilno nastavljen	-Nastavite omejevalnik tople vode
Pretočni grelnik se ne vklopi	-Omejevalnik pretoka ni odstranjen iz ročne prhe -Filtrirni so umazani -Protipovratni ventil je obtičal	-Odstranite omejevalnik pretoka iz ročne prhe -Očistite/zamenjajte filtre -Zamenjajte protipovratni ventil

Omejitev tople vode: temperatura tople vode 60 C, temperatura mrzle vode 10 C, pretočni tlak 0,3 MPa.

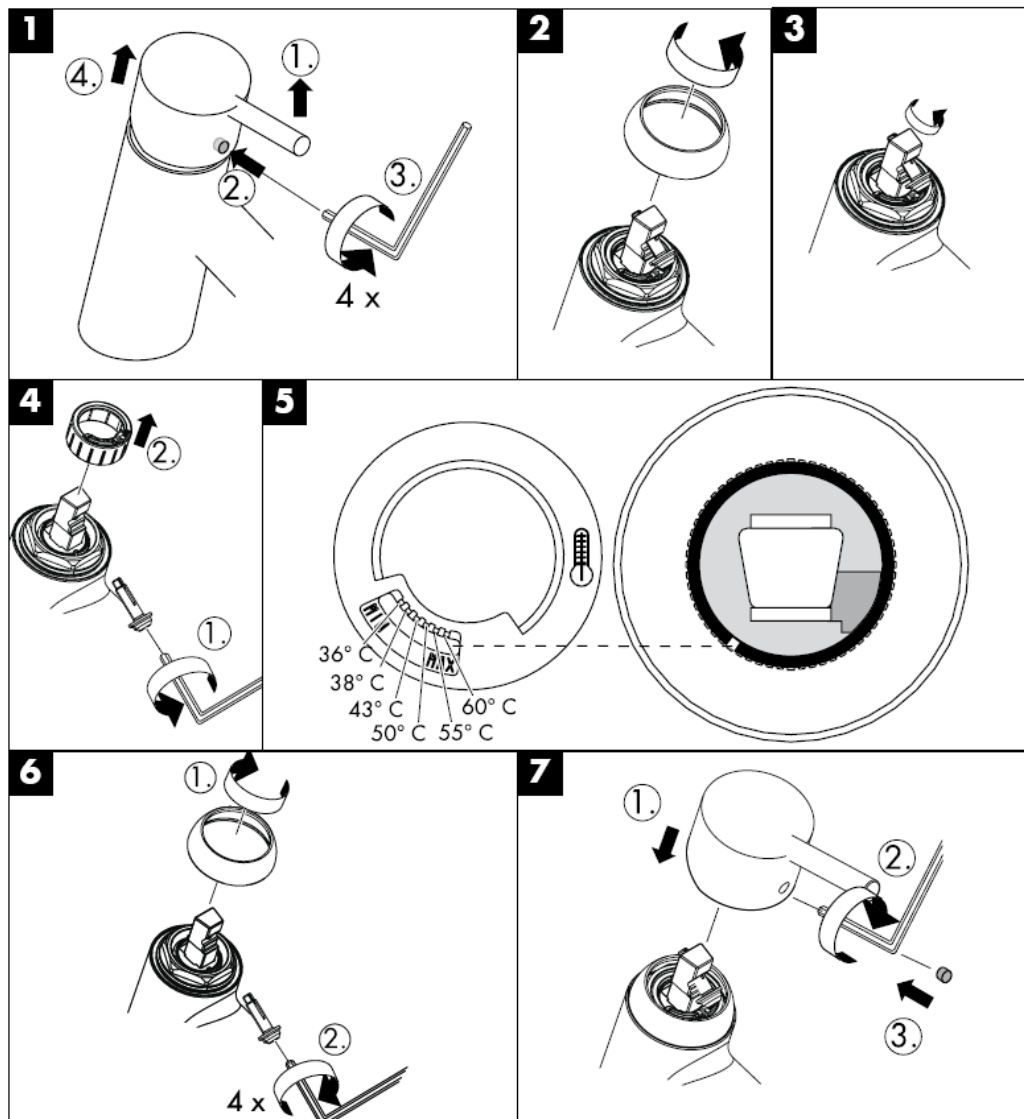

Čiščenje

Z QuickClean, ročno čistilno funkcijo, lahko s šob očistimo vodni kamen tako, da šobe enostavno podrgnemo.

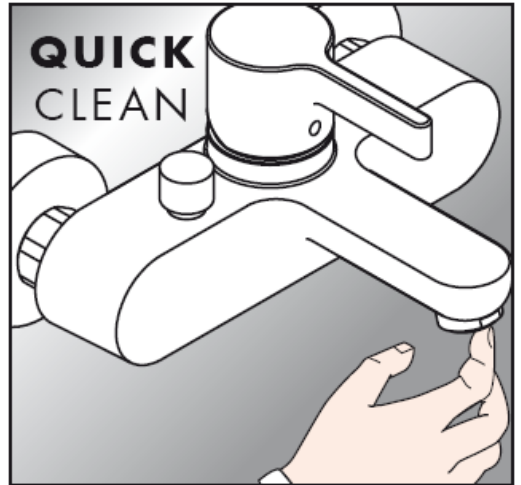

hansgrohe

Hansgrohe · Postfach 1145 · D-77761 Schiltach · Telefon +49 (0) 78 36/51-1282 · Telefax +49 (0) 7836/511440
E-Mail: info@hansgrohe.com · Internet: www.hansgrohe.com

11/2008
9.06851.01
Slovenski

Paigaldusjuhend

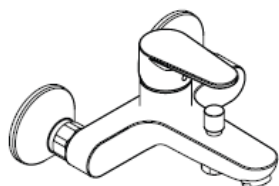

Talis E²
31642000

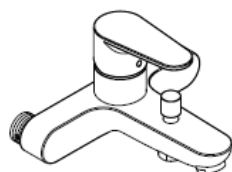

Talis E²
31643000

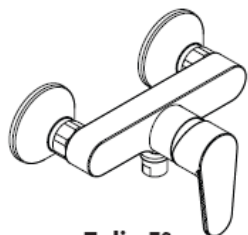

Talis E²
31662000



Talis E²
31667000

hansgrohe

31642000

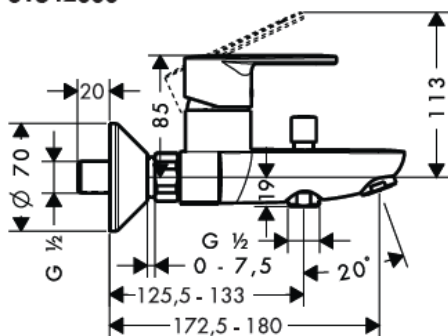

31662000

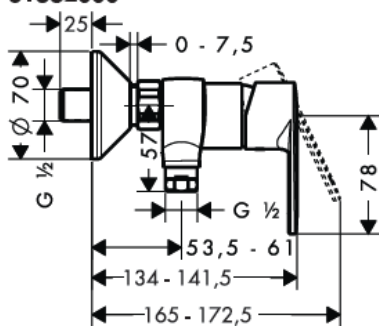

31643000

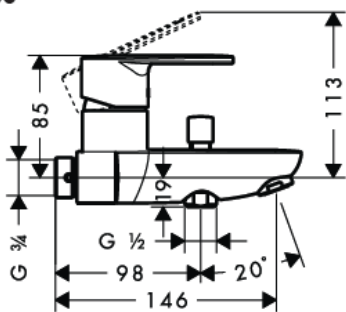

AD 153 mm

31667000

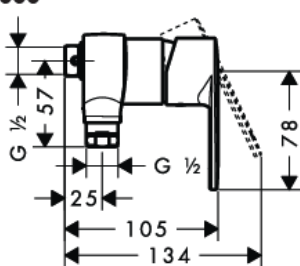

AD 153 mm

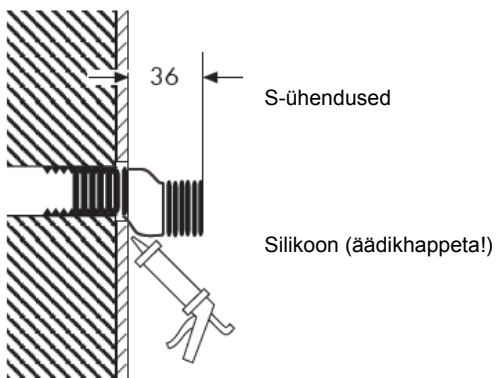



31642000

31662000 / 31667000

31642000 / 31643000



31662000

31643000 / 31667000

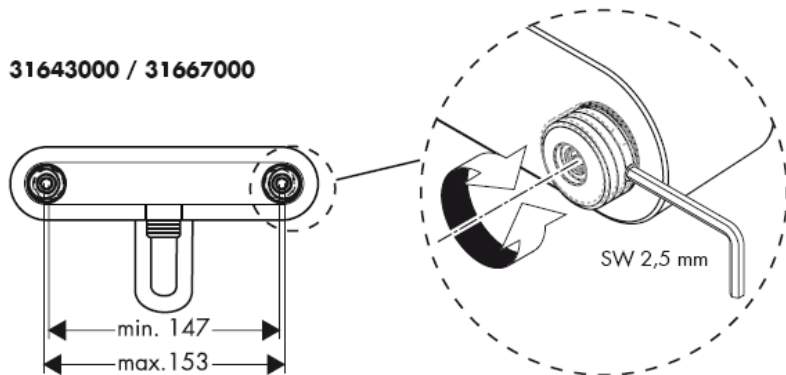

Tähelepanu! Segisti paigaldamine, loputamine ja kontroll peab toimuma vastavalt kehtivatele normidele!

1. Peske etteandeturud läbi.
2. Paigaldage S-ühendused ja seadke otseks
3. Kravige segisti koos tihenditega kinni

Kui külma ja kuuma vee ühenduste surve on väga erinev, tuleb need tasakaalustada.

Kasutamine

Segisti avaneb kangi ülestõstmisel. Vasakule pöörates = kuum vesi, paremale pöörates = külm vesi.
31642000 / 31643000 Käsidušile üleminek toimub väljavoolu kohal oleva ümara nupu tõmbamisega. Vannifunktsioonile üleminek toimub automaatselt käepideme sulgemisega.

Tehnilised andmed

Töörõhk	max. 1 MPa
Soovitav töörõhk:	0,1 – 0,5 MPa
Kontrollsurve:	1,6 MPa
(1 MPa = 10 bar = 147 PSI)	
Kuuma vee temperatuur:	max. 80° C
Soovitav kuuma vee temperatuur:	65° C
distsants keskelt:	
ühendused G ½":	külm paremal, kuum vasakul
Läbivool:	ca. 17 l/min 0,3 MPa
Läbivooluklapp	

Ühe juhtkangiga segisti kuuma vee piiraja reguleerimise kohta vt lk 6. Läbivoolu boilerite puhul pole reguleerimine vajalik.

Hansgrohe ühekäe segisteid võib kasutada koos hüdrauliselt ja termiliselt juhitavate boileritega, kui vee rõhk on vähemalt 0,15 MPa.

Tähelepanu!

Tagasilöögiklappide toimimist tuleb kontrollida vastavalt standardile DIN 1988 kord aastas.

Varuosad (vt lk 3)

1	käepide	31692000
1.1	käepideme kaas	96338000
2	äärrik	97406000
3	mutter	97977000
4	tööelement	92730000
5	äärrik	96135000
6	S-ühendused	94140000
7	õhustaja kpl	96429000
8	muundur kpl.	13956000
9	tõmbenupp	97978000
10	tagasilöögiklapp	97980000

Estonia

Kontrollsertifikaat

	PA-IX	DVGW	SVGW	KIWA	ACS	NF
31642000	PA-IX 18340/ICB	X	X	X	X	
31643000			X			
31662000	PA-IX 18339/IB	X	X	X	X	
31667000			X			

Rike	Põhjus	Lahendus
Vähe vett	-Duši sõeltihend must -Tagasilöögiklapp on kinni	-Puhastage duši ja vooliku vaheline sõeltihend -Tagasilöögiklapp välja vahetada
Segisti käib raskelt	-Tööelement on katkine, lubjastunud	-Vahetage tööelement
Segisti tilgub	-Tööelement on katkine	-Vahetage tööelement
Sooja vee temperatuur liiga madal avatud süsteemi boiler ei lülitu sisse	-Kuum vee piirang valesti seatud -Veehulga piirajat ei ole ära võetud -Filtrid määratud -Tagasilöögiklapp on kinni	-Seadke kuum vee piirang -Eemaldage veehulga piiraja -Puhastage/vahetage filter -Tagasilöögiklapp välja vahetada

Kuuma vee piiraja: kuum vesi 60 C, külm vesi 10 C, rõhk 0,3 MPa.

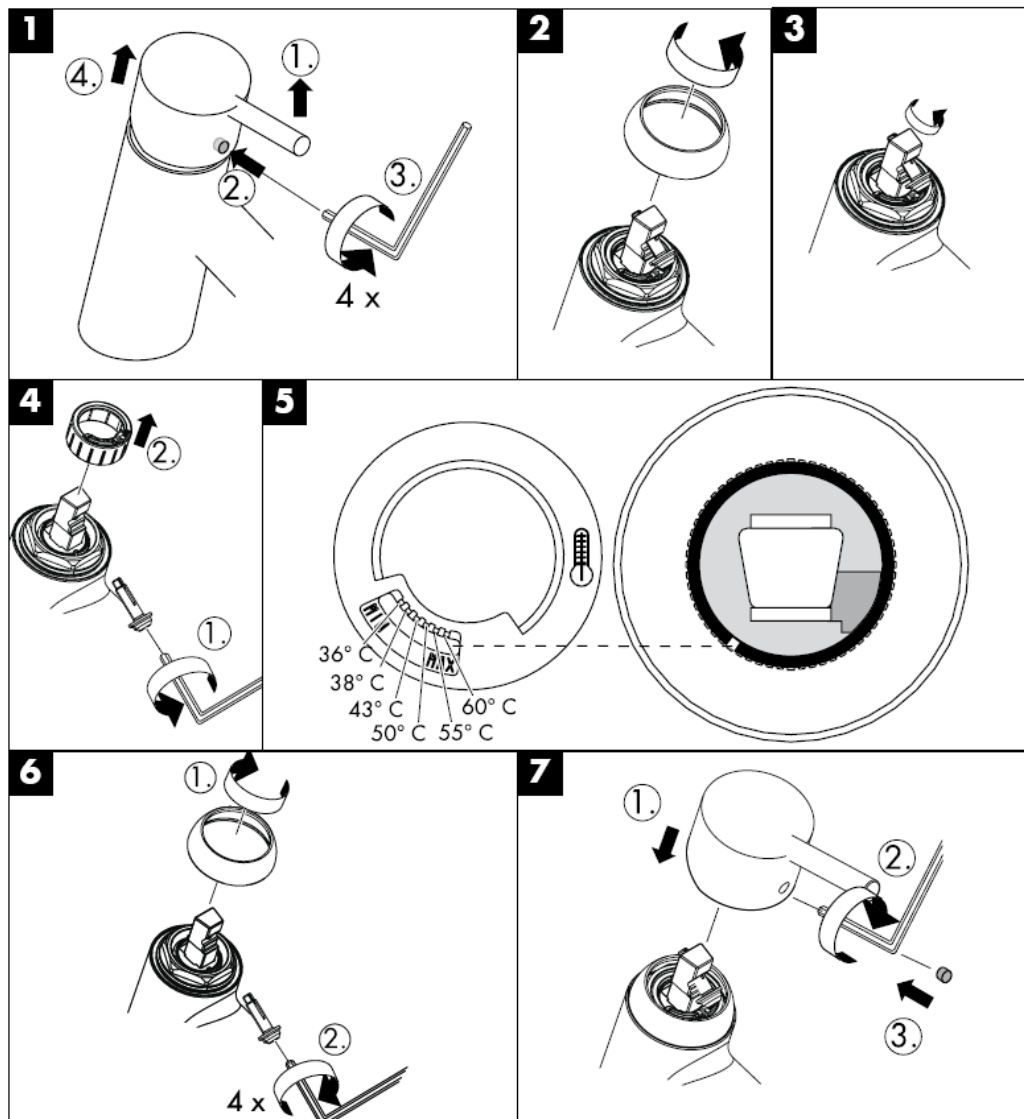

Puhastamine

Käsitsi puhastamise funktsiooni QuickClean puhul on vajalik vaid kerge ülehõõrumine, eemaldamaks dušikanalitest katlakivi.

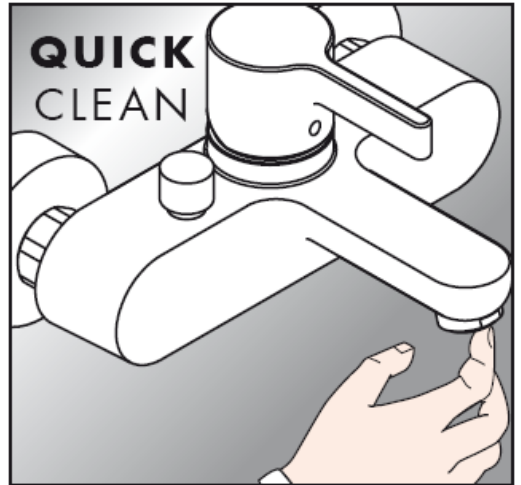

hansgrohe

Hansgrohe · Postfach 1145 · D-77761 Schiltach · Telefon +49 (0) 78 36/51-1282 · Telefax +49 (0) 7836/511440
E-Mail: info@hansgrohe.com · Internet: www.hansgrohe.com

11/2008
9.06851.01
Estonia

Montāžas instrukcija

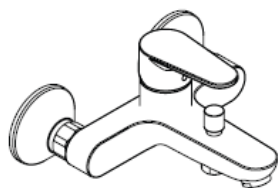

Talis E²
31642000

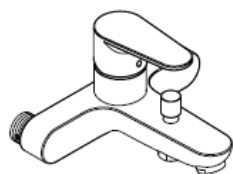

Talis E²
31643000



Talis E²
31662000



Talis E²
31667000

hansgrohe

31642000

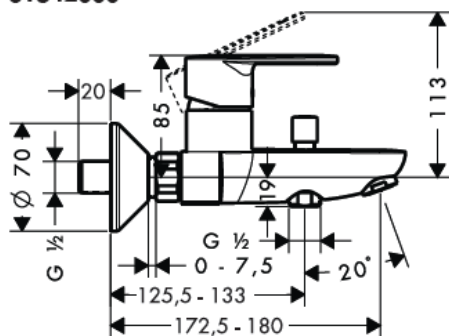

31662000

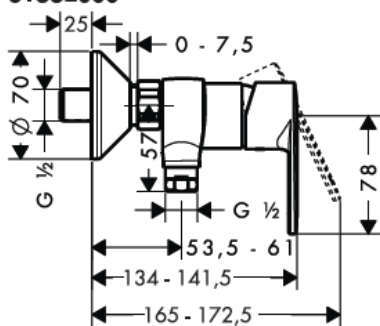

31643000

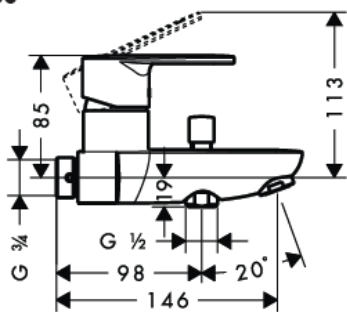

AD 153 mm

31667000

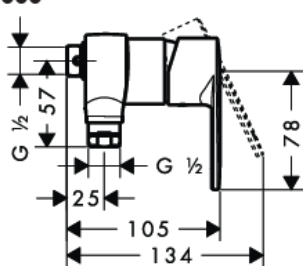

AD 153 mm

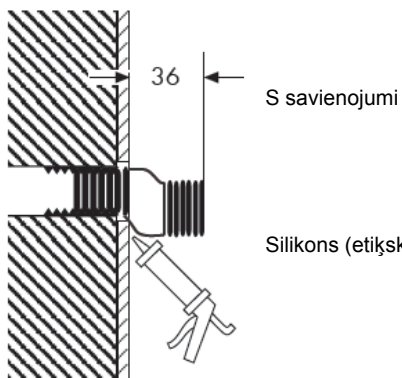



31642000

31662000 / 31667000

31642000 / 31643000



31662000

31643000 / 31667000

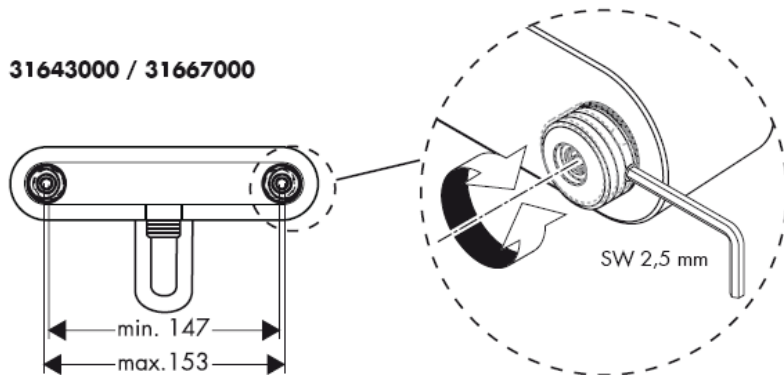

Uzmanību! Armatūra jāuzstāda, jāizskalo un jāpārbauda atbilstoši spēkā esošajām normām!

1. Atbilstoši izskatot pievadus.
2. Montēt un piergulēt S savienojumus.
3. Pieskrūvēt jaucējkrānu ar blīvēm.

Jāizlīdzina spiediena atšķirības starp aukstā un karstā ūdens pievadiem.

Lietošana

Paceļot rokturi, jaucējkrāns tiek atvērts. Pavirzot to pa kreisi = karstāks ūdens, pavirzot pa labi = aukstāks ūdens.

31642000 / 31643000 Pārslēgšana uz rokas dušu notiek, velkot aiz apaļās pogas snīpja virspusē.

Atgriešanās iepriekšējā pozīcijā notiek automātiski, aizgriežot rokturi.

Tehniskie dati

Darba spiediens: max. 1 MPa

Ieteicamais darba spiediens: 0,1 – 0,5 MPa

Pārbaudes spiediens: 1,6 MPa

(1 MPa = 10 bar = 147 PSI)

Karstā ūdens temperatūra: max. 80° C

Ieteicamā karstā ūdens

temperatūra: 65° C

Pieslēguma izmēri:

G ½" pieslēgumi: aukstais pa labi - karstais pa kreisi

Caurteces intensitāte: ca. 17 l/min 0,3 MPa

Drošības vārsts

Viensvires jaucējkrāns ar siltā ūdens ierobežošanu, ieregulēšanu skat. 6. lpp. Kombinācijā ar caurteces sildītāju karstā ūdens ierobežošana nav nepieciešama.

Hansgrohe viensvires jaucējkrānus var izmantot kombinācijā ar hidrauliski un termiski vadāmiem caurteces sildītājiem, ja plūsmas spiediens ir vismaz 0,15 MPa.

Uzmanību!

Reizi gadā jāpārbauda pretvārsti atbilstoši DIN 1988.

Rezerves daļas (skat. 3. lpp.)

1	rokturis	31692000
1.1	dekoratīvs aizbāznis	96338000
2	vāciņš	97406000
3	uzgrieznis	97977000
4	Kartuša, kompl.	92730000
5	Rozete	96135000
6	S savienojumi	94140000
7	Aeratora kompl.	96429000
8	Pārslēdzēju kompl.	13956000
9	Pārslēdzēja poga	97978000
10	Pretvārsts	97980000

Latviski

Pārbaudes zīme

	PA-IX	DVGW	SVGW	KIWA	ACS	NF
31642000	PA-IX 18340/ICB	X	X	X	X	
31643000			X			
31662000	PA-IX 18339/IB	X	X	X	X	
31667000			X			

Traucējums	Iemesls	Bojājumu novēršana
Maz ūdens	-Netīrs dušas filtra blīvējums -Pretvārsts ir iesprūdis	-Iztīrīt filtra blīvējumu starp dušu un šļūteni -Nomainīt pretvārstu
Jaucējkrāns smagi grozāms	-Bojāta kartuša, aizkaļķojusies	-Nomainīt kartušu
Jaucējkrāns pil	-Bojāta kartuša	-Nomainīt kartušu
Pārāk zema ūdens temperatūra	-Nepareizi noregulāta karstā ūdens bloķēšana	-Noregulēt karstā ūdens ierobežošanu
Neieslēdzas caurteces sildītājs	-Rokas dušā nav demontēts vārsts -Filtri netīri -Pretvārsts ir iesprūdis	-Izņemt no rokas dušas vārstu -Tīrīt / nomainīt filtrus -Nomainīt pretvārstu

Karstā ūdens ierobežotājs: karstā ūdens temperatūra 60 C, aukstā ūdens temperatūra 10 C, plūsmas spiediens 0,3 MPa.

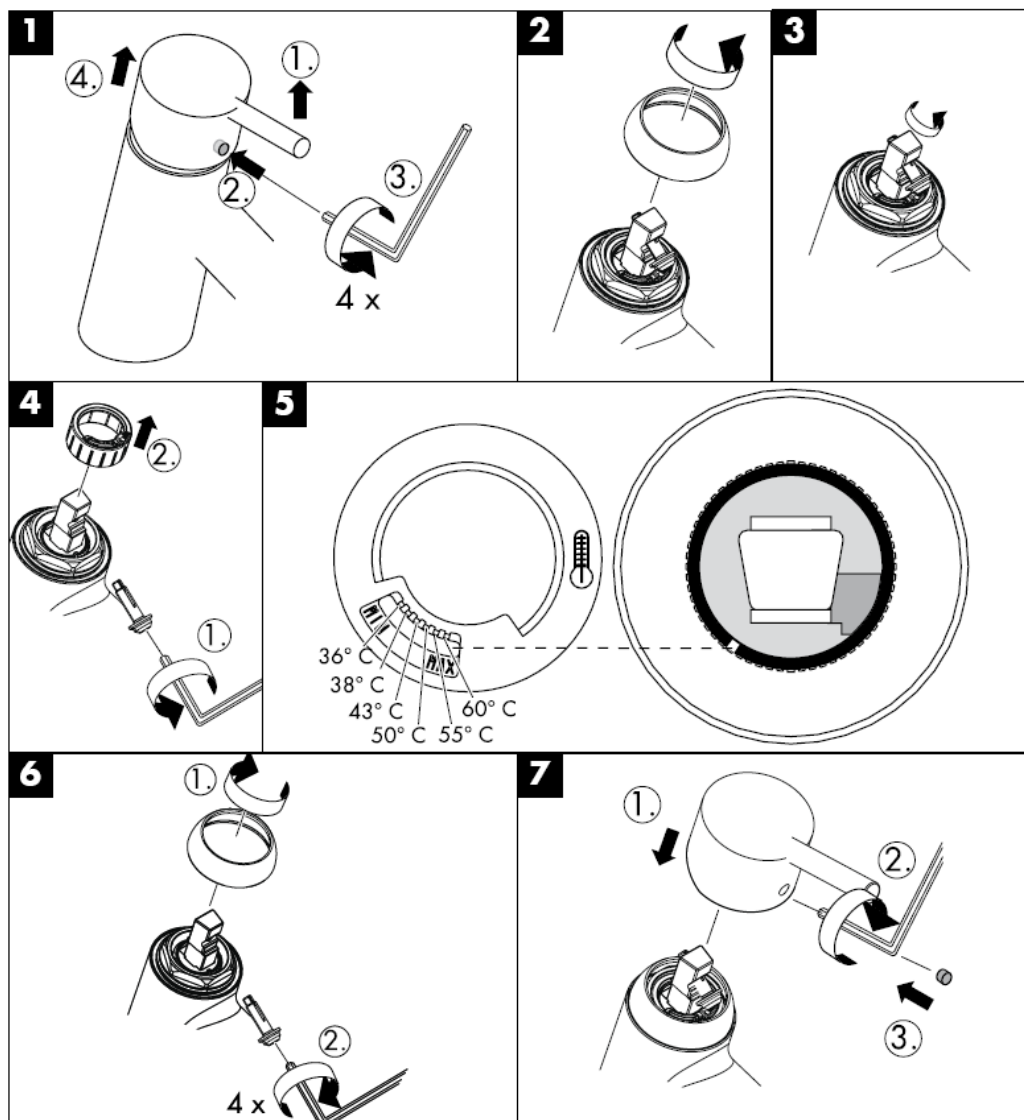

Tīrīšana

QuickClean attīrīšanas funkcija - strūklas kanāliņi vienkāršas manuālas berzes rezultātā tiek attīrīti no kaļķa.

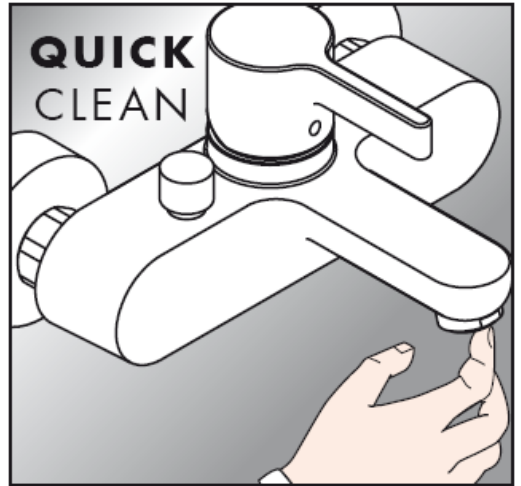

hansgrohe

Hansgrohe · Postfach 1145 · D-77761 Schiltach · Telefon +49 (0) 78 36/51-1282 · Telefax +49 (0) 7836/511440
E-Mail: info@hansgrohe.com · Internet: www.hansgrohe.com

11/2008
9.06851.01
Latviski

Uputstvo za montažu

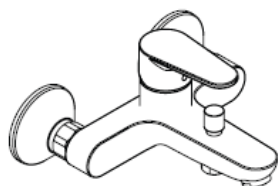

Talis E²
31642000

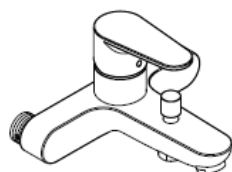

Talis E²
31643000



Talis E²
31662000



Talis E²
31667000

hansgrohe

31642000

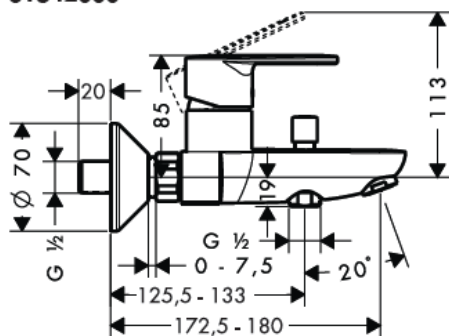

31662000

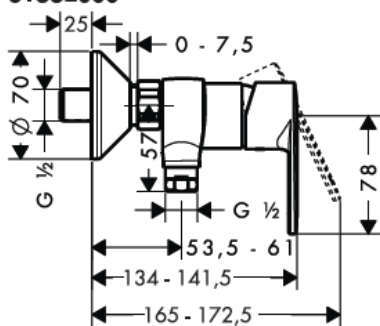

31643000

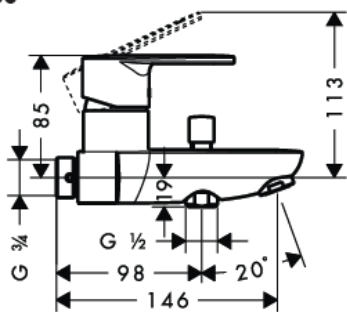

AD 153 mm

31667000

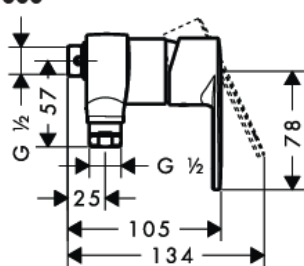

AD 153 mm

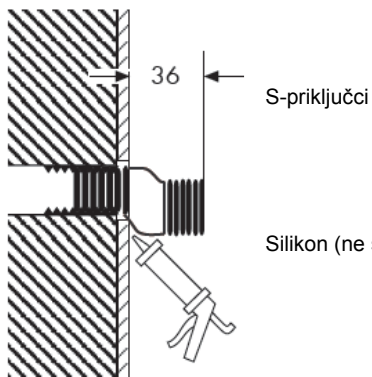

Silikon (ne sadrži sirčetnu kiselinu!)



31642000

31662000 / 31667000

31642000 / 31643000



31662000

31643000 / 31667000

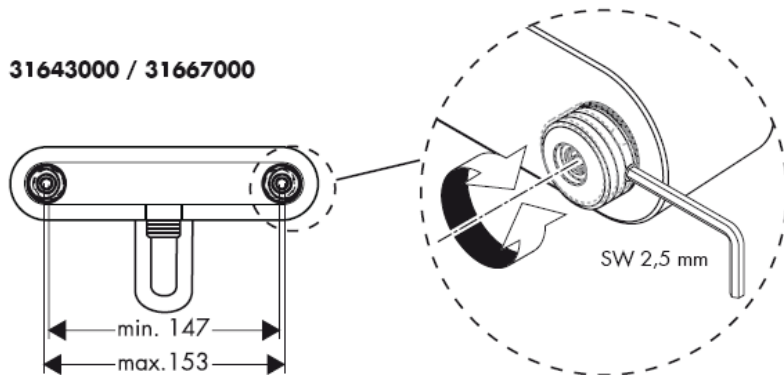

Pažnja! Armatura mora biti postavljena, isprana i testirana prema važećim normama!

1. Isperite cevi dovoda.
2. Postavite i usmerite S – priključke.
3. Armaturu i zaptivke dobro pričvrstite zavrtnjima.

Velika razlika u pritisku između vruće i hladne vode mora biti izbalansirana.

Rukovanje

Mešač se otvara podizanjem ručice.

Okretanje ulevo = vruća voda,

Okretanje udesno = hladna voda.

31642000 / 31643000 Protok se prebacuje sa slavine na tuš podizanjem okruglog dugmeta na gornjem delu cevi slavine. Nakon zatvaranja ručice, automatski se uspostavlja početna situacija.

Tehnički podaci

Radni pritisak: max. 1 MPa

Preporučeni radni pritisak: 0,1 – 0,5 MPa

Probni pritisak: 1,6 MPa

(1 MPa = 10 bar = 147 PSI)

Temperatura vruće vode: max. 80° C

Preporučena temperatura vruće vode: 65° C

Rastojanje između centara priključaka:

Priključci G ½": hladna voda desno – topla levo

Protok vode: ca. 17 l/min 0,3 MPa

Zaštita od povratnog toka

Da bi ste podesili ograničavač vruće vode na jednoručnim mešačima, molimo Vas da pogledate stranicu 6.

Podešavanje nije potrebno ako koristite protočni bojler.

Hansgrohe jednoručni mešači se mogu koristiti s hidraulički i termički kontrolisanim protočnim bojlerima, ako je pritisak najmanje 0,15 MPa.

Pažnja!

Die Rückflussverhinderer müssen gemäß DIN 1988 einmal jährlich auf ihre Funktion geprüft werden.

Rezervni delovi (vidi stranu 3)

1	Ručica	31692000
1.1	Čepovi ručice	96338000
2	kapica	97406000
3	Navrtka	97977000
4	Kartuša kompl.	92730000
5	Rozeta	96135000
6	S-priključci	94140000
7	Aerator kompl.	96429000
8	Preusmerivač kompl.	13956000
9	Potezno dugme	97978000
10	Nepovratni ventil	97980000

Srpski

Ispitni znak

	PA-IX	DVGW	SVGW	KIWA	ACS	NF
31642000	PA-IX 18340/ICB	X	X	X	X	
31643000			X			
31662000	PA-IX 18339/IB	X	X	X	X	
31667000			X			

Smetnja	Uzrok	Pomoć
Nedovoljno vode	-Mrežasta zaptivka tuša je prljava -Nepovratni ventil se nije vratio u početni položaj	-Očistite mrežastu zaptivku između tuša i crijeva -Zamenite nepovratni ventil
Ručica se zaglavila	-Neispravna kartuša, nataloženi kamenac	-Zamenite kartušu
Slavina kaplje	-Neispravna kartuša	-Zamenite kartušu
Preniska temperatura tople vode	-Ograničavač vruće vode nije dobro podešen	-Podesite ograničavač vruće vode
Protočni bojler ne radi	-Prigušnica u ručnom tušu nije odstranjena -Mrežice za hvatanje prljavštine su prljave -Nepovratni ventil se nije vratio u početni položaj	-Odstranite prigušnicu iz ručnog tuša -Očistite / zamenite mrežicu za hvatanje prljavštine -Zamenite nepovratni ventil

Ograničavač vruće vode: temperatura vruće vode 60 °C, temperatura hladne vode 10 °C, pritisak 0,3 MPa.

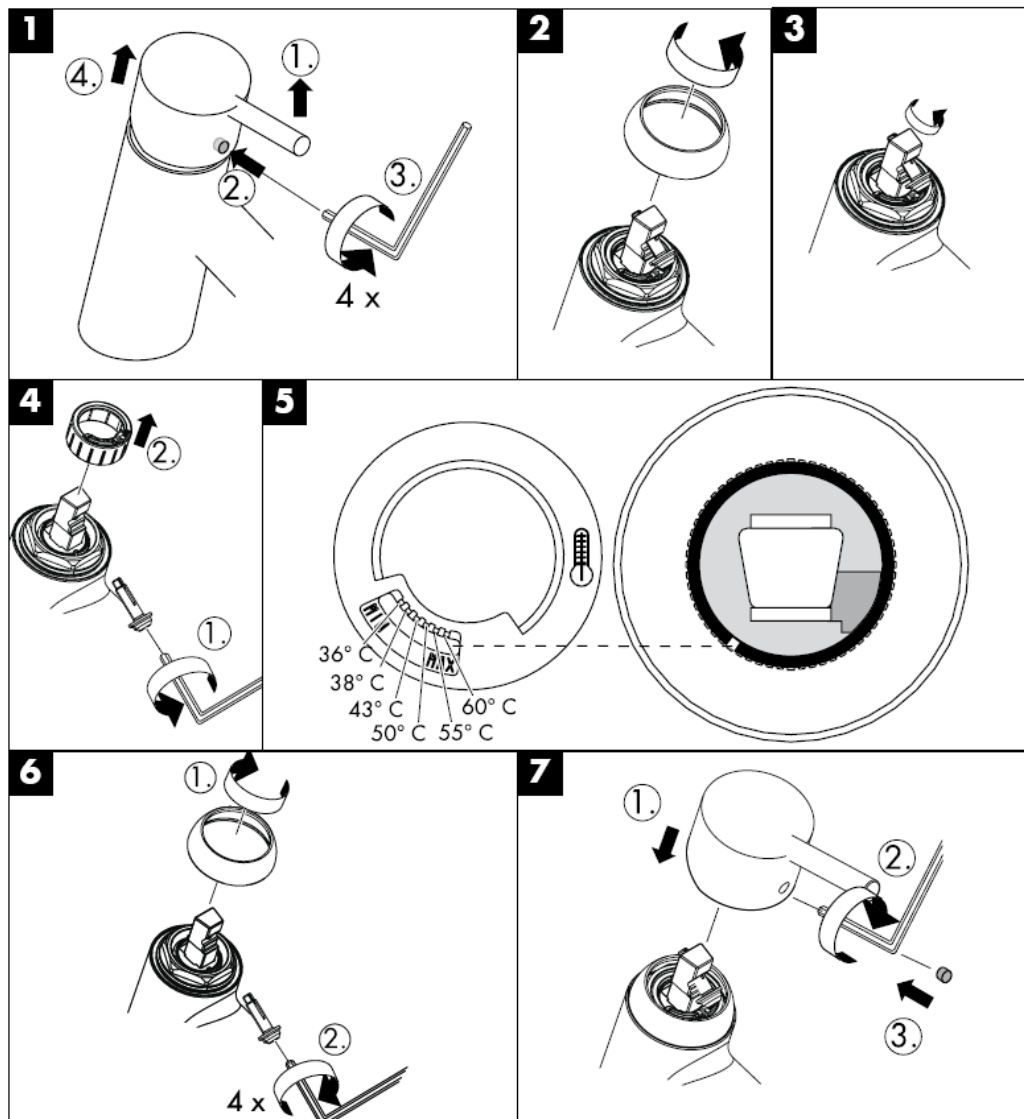

Ispitni znak

QuickClean - ručni sistem za čišćenje omogućuje odstranjivanje kamenca s rupica uobličavača mlaza, jednostavnim trljanjem.

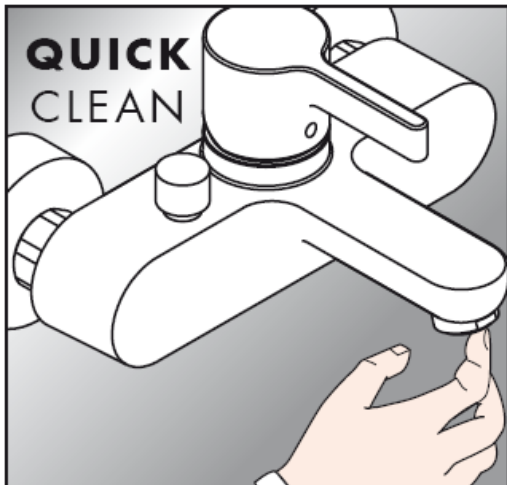

hansgrohe

Hansgrohe · Postfach 1145 · D-77761 Schiltach · Telefon +49 (0) 78 36/51-1282 · Telefax +49 (0) 7836/511440
E-Mail: info@hansgrohe.com · Internet: www.hansgrohe.com

11/2008
9.06851.01
Srpski

Montasjeveiledning

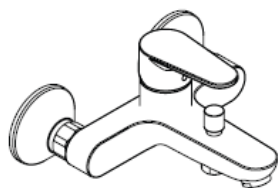

Talis E²
31642000

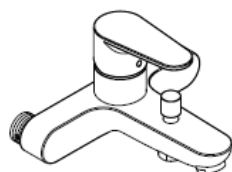

Talis E²
31643000



Talis E²
31662000



Talis E²
31667000

hansgrohe

31642000

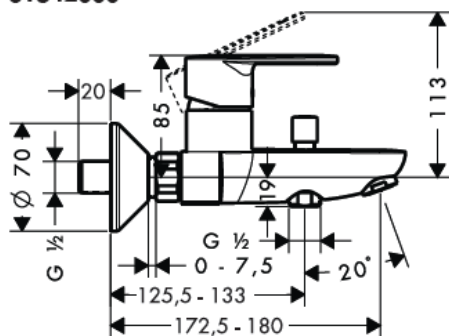

31662000

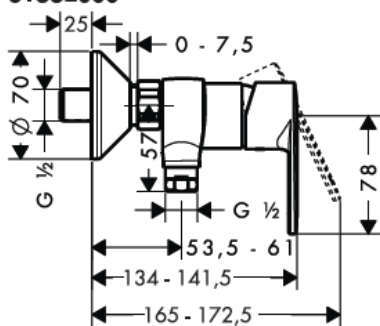

31643000

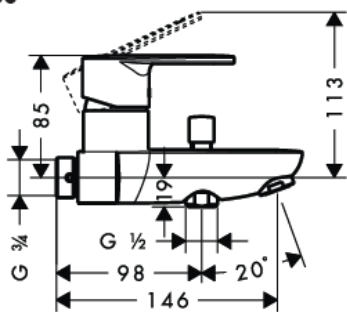

AD 153 mm

31667000

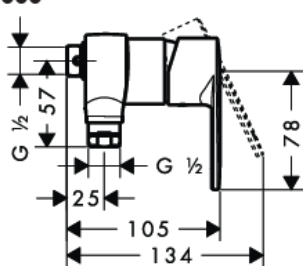

AD 153 mm

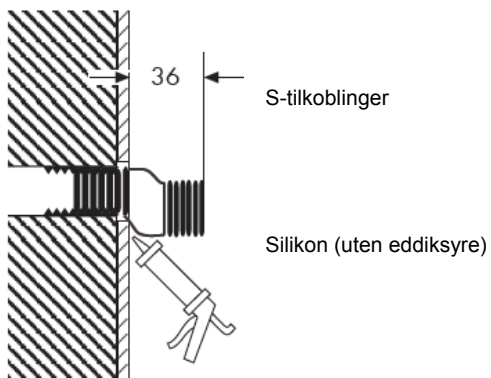



31642000

31662000 / 31667000

31642000 / 31643000



31662000

31643000 / 31667000

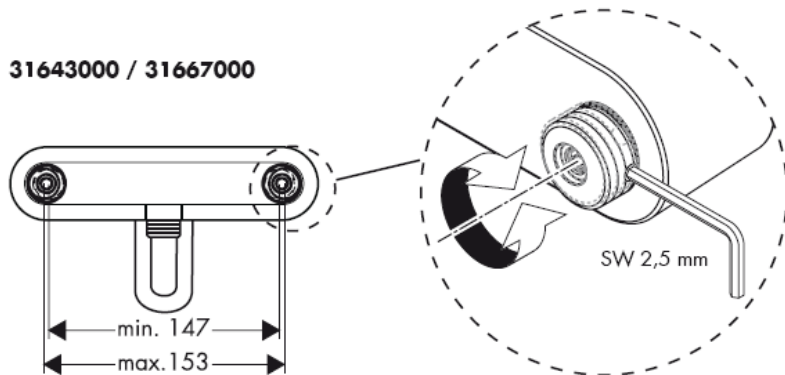

Obs! Armaturen skal monteres iht. gyldige standarder. De skal spyles og sjekkes!

1. Forsyningsledninger spyles faglig korrekt.
2. S-tilkoblinger monteres og rettes inn.
3. Armatur trekkes fast med pakninger.

Store trykkdifferanser mellom kaldt- og varmtvannstilkoblinger skal utlignes.

Betjening

Blandebatteriet åpnes ved løfting av grepet. Drei til venstre = varmt vann, drei til høyre = kaldt vann. 31642000 / 31643000 Omstilling på hånddusj ved å trekke i den runde knappen på utløpets overside. Automatisk tilbakestilling skjer etter at grepet lukkes.

Tekniske data

Driftstrykk	max. 1 MPa
Anbefalt driftstrykk:	0,1 – 0,5 MPa
Prøvetrykk	1,6 MPa
(1 MPa = 10 bar = 147 PSI)	
Varmtvannstemperatur	max. 80° C
Anbefalt temperatur for varmt vann	65° C
Tilkoblingsmål:	
Tilkoblinger G ½"	kaldt høyre - varm venstre
Gjennomstrømningsytelse:	ca. 17 l/min 0,3 MPa
Egensikker mot tilbakeflyt	

Enhåndblandebatteri med varmtvannsbegrensning. For justering se side 6. I forbindelse med en gjennomstrømningsovner er det ikke nødvendig med varmtvannsbegrensning.

Armaturer fra Hansgrohe kan brukes sammen med hydraulisk og termisk stryrtte gjennomstrømningsovner når gjennomstrømningstrykket er på minst 0,15 Mpa.

Obs!

I henhold til DIN 1988 skal funksjonen til returløpssperren sjekkes en gang i året.

Serviceteile (se side 3)

1	Grep	31692000
1.1	Grepplugg	96338000
2	Kappe	97406000
3	Mutter	97977000
4	Kartusj	92730000
5	Rosett	96135000
6	S-tilkoblinger	94140000
7	Luftsprudler kpl.	96429000
8	Omstiller kpl.	13956000
9	Trekk-knapp	97978000
10	Returløpssperre	97980000

Norsk

Prøvemerke

	PA-IX	DVGW	SVGW	KIWA	ACS	NF
31642000	PA-IX 18340/ICB	X	X	X	X	
31643000			X			
31662000	PA-IX 18339/IB	X	X	X	X	
31667000			X			

Feil	Årsak	Feilrettelse
Lite vann	-Dusjens silpakning er skitten -Returløpstopper sitter fast	-Silpakning mellom dusj og slangen rengjøres -Returløpstopper byttes
Armaturløp ikke lett bevegelig	-Kartusj defekt, forkalkning	-Kartusj byttes
Armaturløp drypper	-Kartusj defekt	-Kartusj byttes
For lav varmtvannstemperatur	-Varmtvannsbegrensning er feil innstilt	-Varmtvannsbegrensning innstilles
Gjennomstrømningsovn innkobler ikke.	-Drossel til hånddusjen ikke fjernet -Smussfangersil skitten -Returløpstopper sitter fast	-Drossel fjernes fra hånddusjen -Smussfangersil rengjøres / byttes -Returløpstopper byttes

Varmtvannsbegrensning: Varmtvanns-temperatur 60 C, kaldtvanns-temperatur 10 C, gjennomstrømsstrykk 0,3 bar.

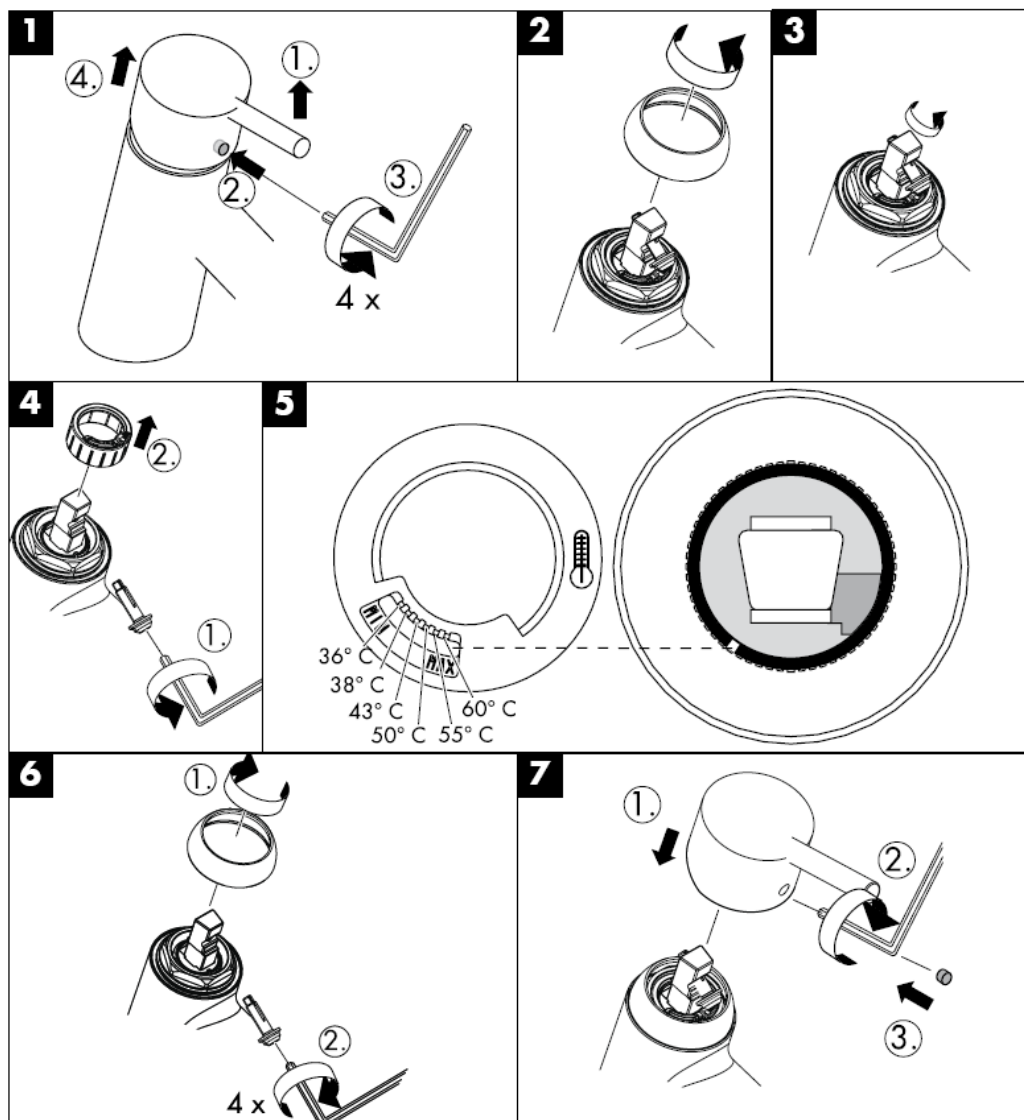

Rengjøring

Med Quiclean, den manuelle rengjøringsfunksjonen, kan stråleformere renses for kalk ved hjelp av enkel gnikking.

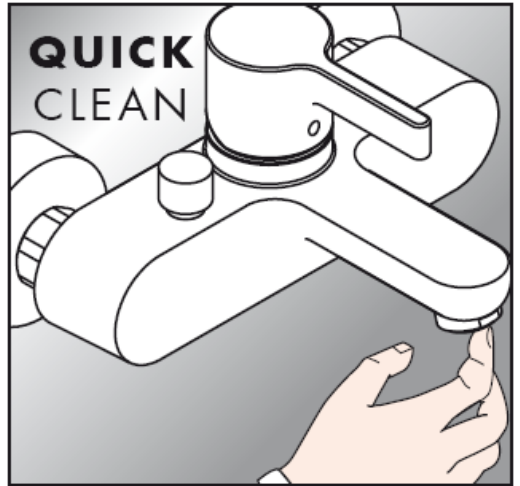

hansgrohe

Hansgrohe · Postfach 1145 · D-77761 Schiltach · Telefon +49 (0) 78 36/51-1282 · Telefax +49 (0) 7836/511440
E-Mail: info@hansgrohe.com · Internet: www.hansgrohe.com

11/2008
9.06851.01
Norsk

РЪКОВОДСТВО ЗА МОНТАЖ

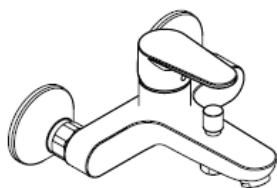

Talis E²
31642000

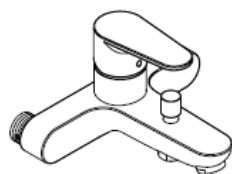

Talis E²
31643000

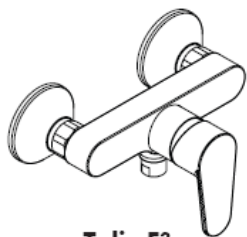

Talis E²
31662000



Talis E²
31667000

hansgrohe

31642000

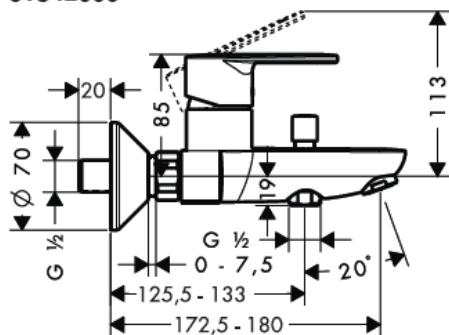

31662000

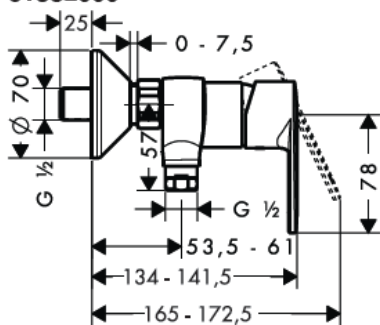

31643000

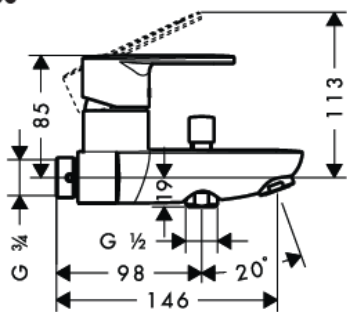

AD 153 mm

31667000

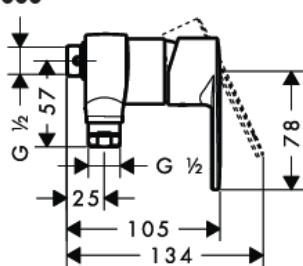

AD 153 mm

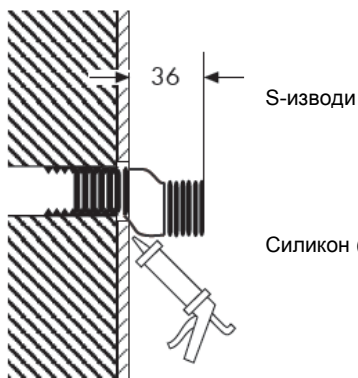



31642000

31662000 / 31667000

31642000 / 31643000



31662000

31643000 / 31667000

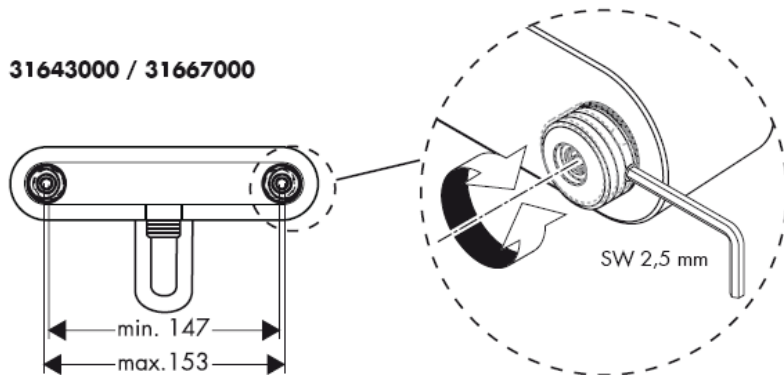

Внимание! Арматурата трябва да се монтира, промие и провери в съответствие с валидните норми!

1. Промийте захранващите тръбопроводи съобразно изискванията.
2. Монтаж и подравняване на S-изводите.
3. Затегнете арматурата с уплътнения.

Големите разлики в налягането между изводите за студената и топлата вода трябва да се изравняват.

Обслужване

След повдигане на дръжката смесителят се отваря. Завъртане наляво = топла вода, Завъртане надясно = студена вода.
31642000 / 31643000 Превключване към ръчен разпръсквател посредством изтегляне на кръглото копче на горната страна на изходящия накрайник. Връщането обратно се извършва автоматично след затваряне на ръкохватката.

Технически данни

Работно налягане: max. 1 MPa
Препоръчително работно налягане: 0,1 – 0,5 MPa
Контролно налягане: 1,6 MPa
(1 MPa = 10 bar = 147 PSI)
Температура на горещата вода: max. 80° C
Препоръчителна температура на горещата вода: 65° C
Присъединителни размери:
Изводи G ½": студено отлясно – топло отляво
Мощност на потока: са. 17 l/min 0,3 MPa
Самозащитен против обратно изтичане

Смесител с една ръкохватка с ограничител за топлата вода, юстирането вижте на стр. 6.
Във връзка с проточни нагреватели не е необходима блокировка за топлата вода.

Смесителите с една ръкохватка на Hansgrohe могат да се използват във връзка с хидравлично и термично управляеми проточни нагреватели, ако хидравличното налягане е минимум 0,15 МПа.

Внимание!

Съгласно DIN 1988 веднъж годишно трябва да се проверява функцията на приспособленията, предотвратяващи обратния поток.

Сервизни части (siehe Seite 3)

1	Ръкохватка	31692000
1.1	Пробка на ръкохватката	96338000
2	Капачка	97406000
3	Гилзи компл.	97977000
4	Гилзи компл.	92730000
5	Розетка	96135000
6	S-изводи	94140000
7	Аератор компл.	96429000
8	Превключватели компл.	13956000
9	Копче за изтегляне	97978000
10	Приспособление, предотвратяващо обратния поток	97980000

БЪЛГАРСКИ

	PA-IX	DVGW	SVGW	KIWA	ACS	NF
31642000	PA-IX 18340/ICB	X	X	X	X	
31643000			X			
31662000	PA-IX 18339/IB	X	X	X	X	
31667000			X			

Помощ	Малко вода	Замърсено е уплътнението с цедка на разпръсквателя
Почистете уплътнението с цедка между разпръсквателя и маркуча	-Здраво стоящо приспособление за предотвратяване на обратния поток -Трудно подвижна арматура	-Смяна на приспособлението за предотвратяване на обратния поток -Дефектна гилза, покрита с варовик
Сменете гилзата	-Дефектна гилза -Твърде ниска температура на водата	-Сменете гилзата -Ограничението за топлата вода е грушно настроено
Настройте ограничението за топлата вода	-Проточният нагревател не се включва	-Дроселът в ръчния разпръсквател не е демонтиран
Отстранете дросела от ръчния разпръсквател	-Цедките за улавяне на замърсяванията са замърсени -Здраво стоящо приспособление за предотвратяване на обратния поток -Арматурата капе	-Почистете / сменете цедките за улавяне на замърсяванията -Смяна на приспособлението за предотвратяване на обратния поток -

Ограничител за топлата вода: Температура на топлата вода 60 C, Температура на студената вода 10 C, хидравлично налягане 0,3 МПа.

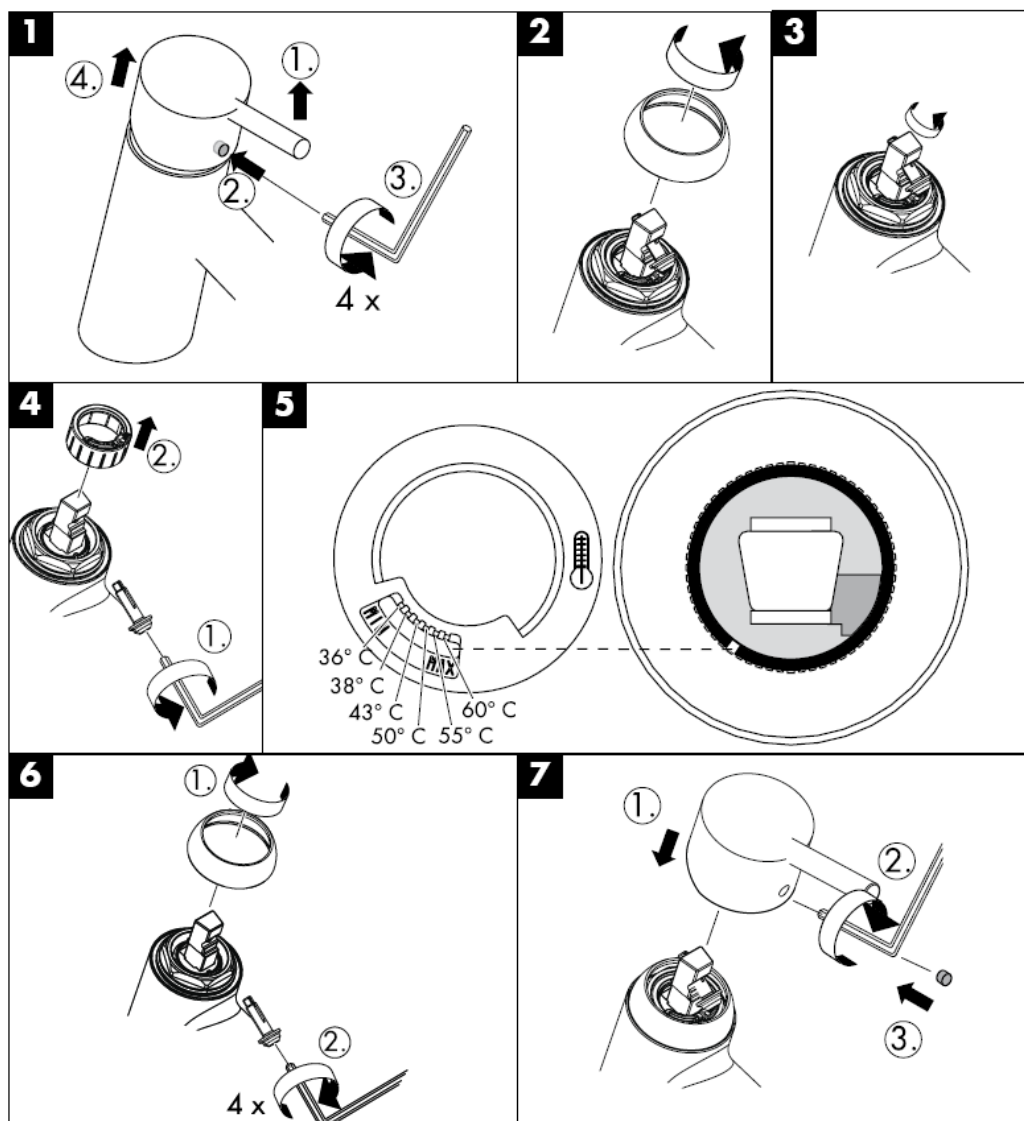

С QuickClean, ръчната функция за почистване, приспособленията за оформяне на струята могат да се почистват от варовика с просто разтъркване.

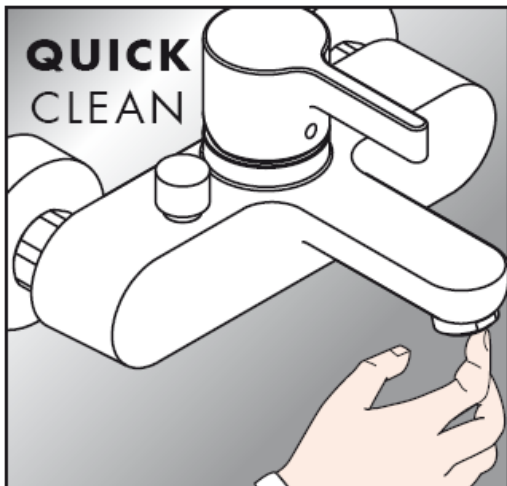

hansgrohe

Hansgrohe · Postfach 1145 · D-77761 Schiltach · Telefon +49 (0) 78 36/51-1282 · Telefax +49 (0) 7836/511440
E-Mail: info@hansgrohe.com · Internet: www.hansgrohe.com

11/2008
9.06851.01
БЪЛГАРСКИ

Udhëzime rreth montimit

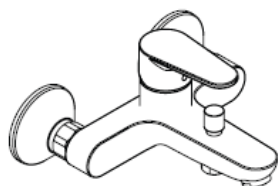

Talis E²
31642000

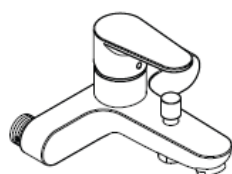

Talis E²
31643000

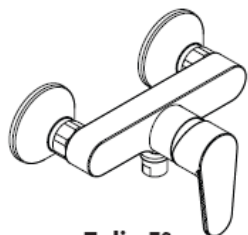

Talis E²
31662000



Talis E²
31667000

hansgrohe

31642000

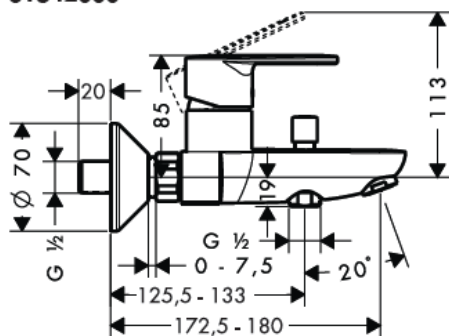

31662000

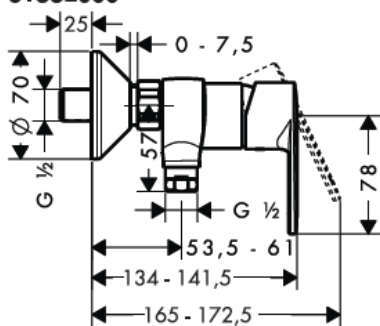

31643000

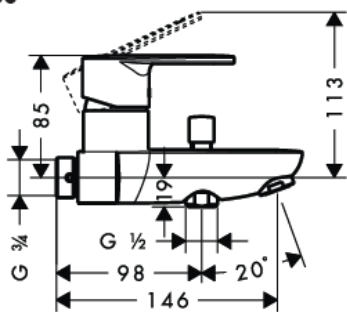

AD 153 mm

31667000

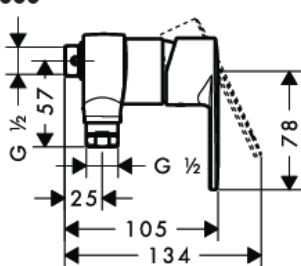

AD 153 mm

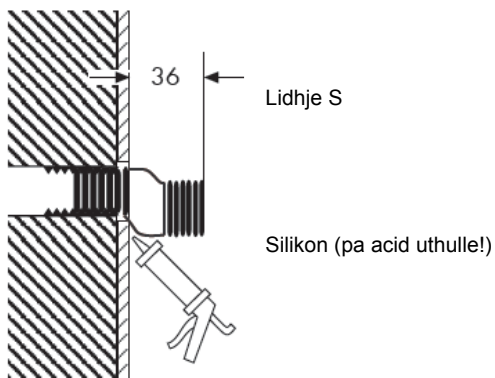



31642000

31662000 / 31667000

31642000 / 31643000



31662000

31643000 / 31667000

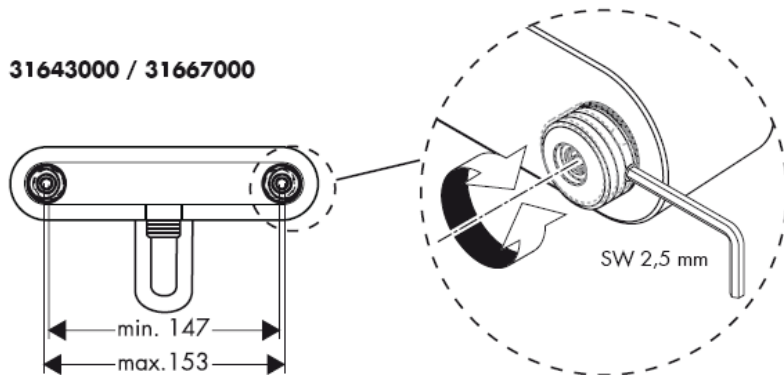

Kujdes! Armatura duhet montuar, shpërlarë dhe kontrolluar në bazë të normave të vlefshme!

1. Shpërlani në mënyrë profesionale lidhjet.
2. Lidhjet S duhen montuar dhe drejtuar.
3. Vidhosni armaturën me shtupë.

Ndryshimet e mëdha të presionit mes lidhjeve të ujit të ftohtë dhe atij të ngrohtë duhen ekuilibruar.

Përdorimi

Rubineti me ujë të përzier hapet duke ngritur lart dorezën.

Rrotullimi majtas = ujë i ngrohtë,

rrotullimi djathtas = ujë i ftohtë.

31642000 / 31643000 Ndërimi i pozicionit në atë të spërkatëses së dorës përmes tërheqjes së butonit të rrumbullakët në pjesën e sipërme të daljes. Kthimi në pozicionin e mëparshëm bëhet automatikisht pas mbylljes së dorezës.

Të dhëna teknike

Presioni gjatë punës max. 1 MPa

Presioni i rekomanduar: 0,1 – 0,5 MPa

Presioni për provë: 1,6 MPa

(1 MPa = 10 bar = 147 PSI)

Temperatura e ujit të ngrohtë max. 80° C

Temperatura e rekomanduar e ujit të ngrohtë: 65° C

Përmasat e lidhjeve:

Lidhjet G ½": i ftohtë djathtas - i ngrohtë majtas

Kapaciteti i rrjedhjes: ca. 17 l/min 0,3 MPa

Siguresa kundër rrjedhjes në drejtim të kundërt

Rubinet me ujë të përzier me kufizim të ujit të ngrohtë, justimi shih faqen 6.

Në kombinim me ngrohësit elektrikë të ujit nuk ka nevojë për bllokadë të ujit të ngrohtë.

Armaturat me ujë të përzier të Hansgrohe mund të përdoren në kombinim me ngrohës elektrikë të ujit të drejtuar në mënyrë hidraulike ose termike nëse presioni i rrjedhjes është minimumi 0,15 MPa.

Kujdes!

Penguesit e rrjedhjes në drejtim të kundërt në bazë të normës DIN 1988 duhen kontrolluar njëherë në vit.

Pjesët e servisit (shih faqen 3)

1	Griff	31692000
1.1	Tapë për dorezën	96338000
2	Mbulesë	97406000
3	Kaseta komplet	97977000
4	Rozeta	92730000
5	Rozeta	96135000
6	Lidhje S	94140000
7	Perlator komplet	96429000
8	Ndërruesi komplet	13956000
9	Butoni tërheqës	97978000
10	Penguesi i rrjedhjes në drejtim të kundërt	97980000

Shqib

	PA-IX	DVGW	SVGW	KIWA	ACS	NF
31642000	PA-IX 18340/ICB	X	X	X	X	
31643000			X			
31662000	PA-IX 18339/IB	X	X	X	X	
31667000			X			

Pak ujë	Gomina hermetizuese e pajisjes me papasterti	Pastroni gominen e sites midis pajisjes dhe tubit
Penguesi i rrjedhjes mbrapsht te ujit qendron i fiksuar	-Kembeni pernguesin e rrjedhjes mbrapsht te ujit -Kartusha me defekt, me kalk	-Armatura punon rende -Kembeni kartushen
Kartusha me defekt	-Kembeni kartushen	-Temperaturë e ulët e ujit të ngrohtë
	-Kufiri i ujit te ngrohte eshte regjistruar gabim	-Regjistroni kufirin e ujit te ngrohte
Ngrohësi i ujit nuk ndizet.	-Rregulluesi i ujit në tubacione nuk është i hequr nga spërkatësja	-Hiqni rregulluesin e ujit në tubacione nga spërkatësja
Sita qe mbledh papastertite eshte e piset	-Pastroni/Kembeni siten qe mbledh papastertite -Kembeni pernguesin e rrjedhjes mbrapsht te ujit	-Penguesi i rrjedhjes mbrapsht te ujit qendron i fiksuar -Armatura pikon -

Kufizimi i ujit të ngrohtë: Temperatura e ujit të ngrohtë 60 C, temperatura e ujit të ftohtë 10 C, presioni i rrjedhjes 0,3 MPa.

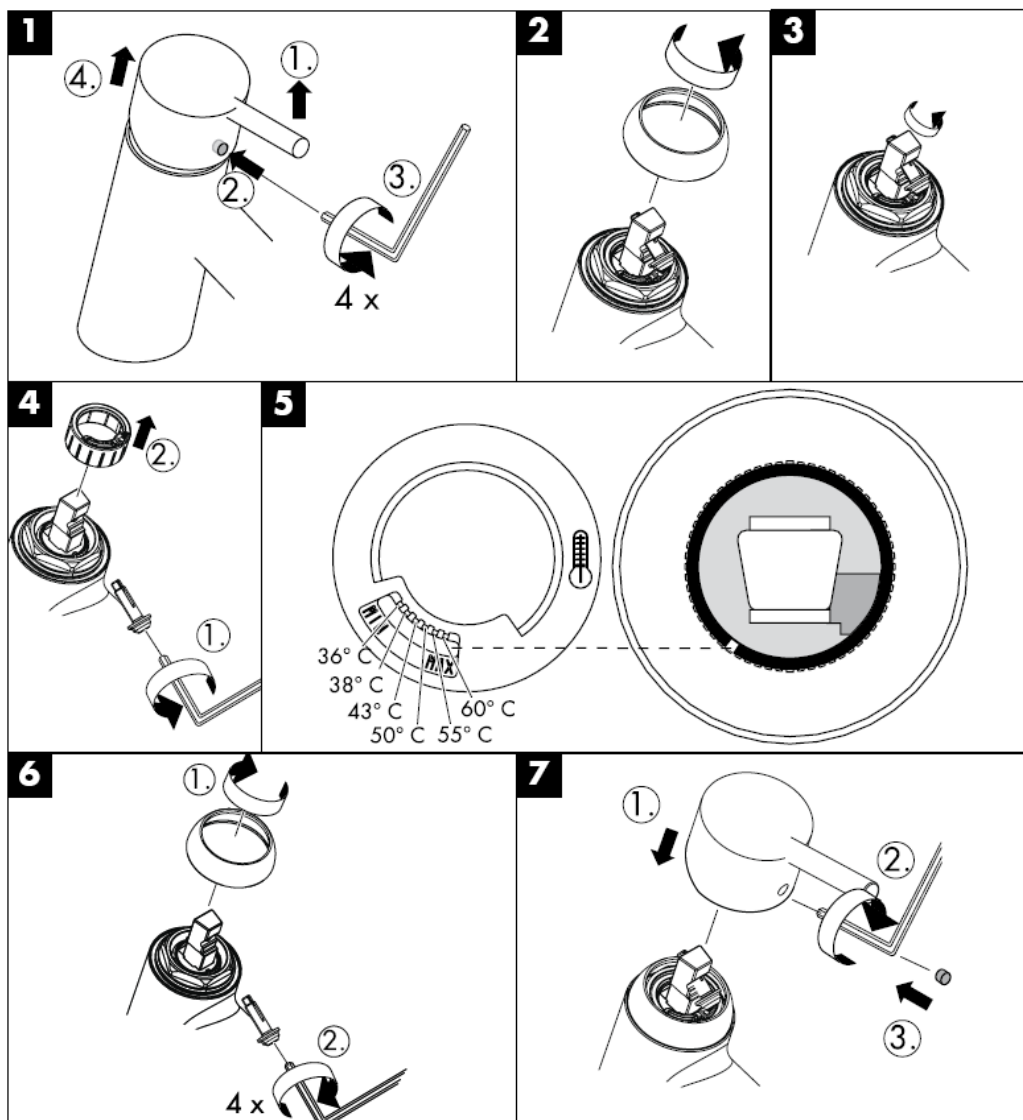

Me QuickCleanit®, funksionin manual të pastrimit mund të hiqen mbetjet gëlqerore me fërkim të thjeshtë nga formuesit e currillit.

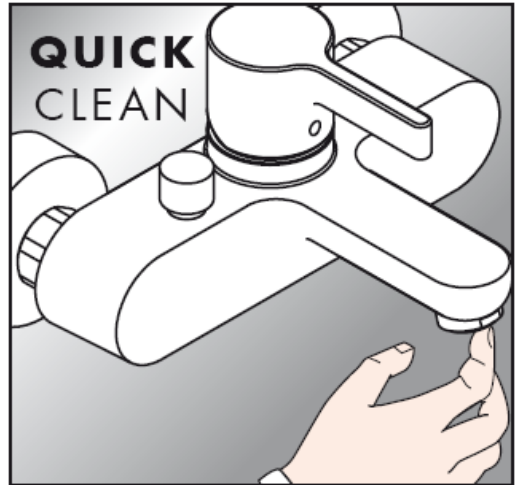

hansgrohe

Hansgrohe · Postfach 1145 · D-77761 Schiltach · Telefon +49 (0) 78 36/51-1282 · Telefax +49 (0) 7836/511440
E-Mail: info@hansgrohe.com · Internet: www.hansgrohe.com

11/2008
9.06851.01
Shqib